



SUBARU











Informationen für Rettungsdienste

Bitte beachten Sie:











Die in den einzelnen Rettungskarten geschilderten Angaben sind ausschließlich für die Nutzung durch Rettungsdienste zusammengestellt und nicht für die herkömmliche Arbeit an Fahrzeugen gedacht. SUBARU Kunden finden detaillierte Sicherheitshinweise zu den Funktionen Ihres Fahrzeuges in der Bedienungsanleitung. Werkstätten und Händler erhalten Reparaturhandbücher durch die von uns bekanntgegebenen Bezugsquellen.



Rettungskarten













Justy	Typ M3	2008-2010	
Impreza	Typ G3	2008-2011	
XV	Typ G4	2012-2017	
Impreza	Typ G4	2012-2017	
XV	Typ G5	2018-2023	
Forester	Typ SH/SHS	2008-2013	
Forester	Typ SJ	2013-2019	
Legacy Limousine	Typ BL/BP BL/BPS	2004-2009	
Legacy Kombi	Typ BL/BP BL/BPS	2004-2009	
Legacy Limousine	Typ BM/BR BM/BRS	2010-2014	



Legacy Kombi	Typ BM/BR BM/BRS	2010-2014	
Outback	Typ BL/BP BL/BPS	2004-2009	
Outback	Typ BM/BR BM/BRS	2010-2014	
Outback	Typ BSD/BS9	2015-2020	
Outback	Typ B7/BT9	ab MJ 2021	
Tribeca	Typ WX	2008-2009	
WRX Sti / Impreza STi	Typ G3	2010-2014	
WRX Sti / Impreza STi	Typ V1	2015-2018	
BRZ	Typ ZC	2013-2022	
BRZ	Typ GD	ab MJ 2023	
Levorg	Typ VM	2016-2021	



Rettungskarten für Fahrzeuge mit Hybridantrieb

Forester		Typ S5	2020-2024	
Impreza		Typ G5	2020-2023	
XV		Typ G5	2020-2023	
Impreza		Typ G6	ab MJ 2024	
Crosstrek		Typ G6	ab MJ 2024	
Forester		Typ S6	ab MJ 2025	

Rettungskarten für Fahrzeuge mit Batterie-elektrischem Antrieb

Solterra		Typ EAM1S(M)	ab MJ 2023	
-----------------	---	--------------	------------	---



Wie sollten sich Rettungskräfte verhalten, wenn die Airbags im Unfallfahrzeug nicht gezündet haben?

- Zündung ausschalten.
- Beide Batteriekabel abklemmen oder durchtrennen.
- Beschädigungen der Airbag-Module im Lenkrad oder Armaturenbrett (z. B. durch Schneiden oder Bohren) vermeiden.
- Hitzeeinwirkung im Bereich des Lenkrades und der Armaturenbrettabdeckung vor dem Beifahrersitz vermeiden. Eine Temperatur von ca. 200 ° C am Gasgenerator führt zur Auslösung des Airbags, auch wenn die Batterie abgeklemmt wurde.
- Werden bei Rettungsarbeiten einzelne Fahrzeugteile bewegt oder elektr. Leitungen durchtrennt, ist eine Airbag-Auslösung nicht auszuschließen. Daher bei Rettungsarbeiten im Bereich Fahrer- Beifahrersitz größte Vorsicht anwenden! Kopf und Oberkörper nicht in den Wirkungsbereich des Airbags bringen.
- Beim SUBARU Justy Modelljahr 1996 erfolgt die Auslösung des Airbags rein mechanisch. Achtung! Bei diesen Fahrzeugen hat das Abklemmen der Batterie keine Wirkung. Hier ist es wichtig Lenksäule / Lenkrad schonend zu behandeln, da hier der Sensor angebracht ist.

Geht von den nicht ausgelösten Airbags überhaupt eine Gefahr aus?





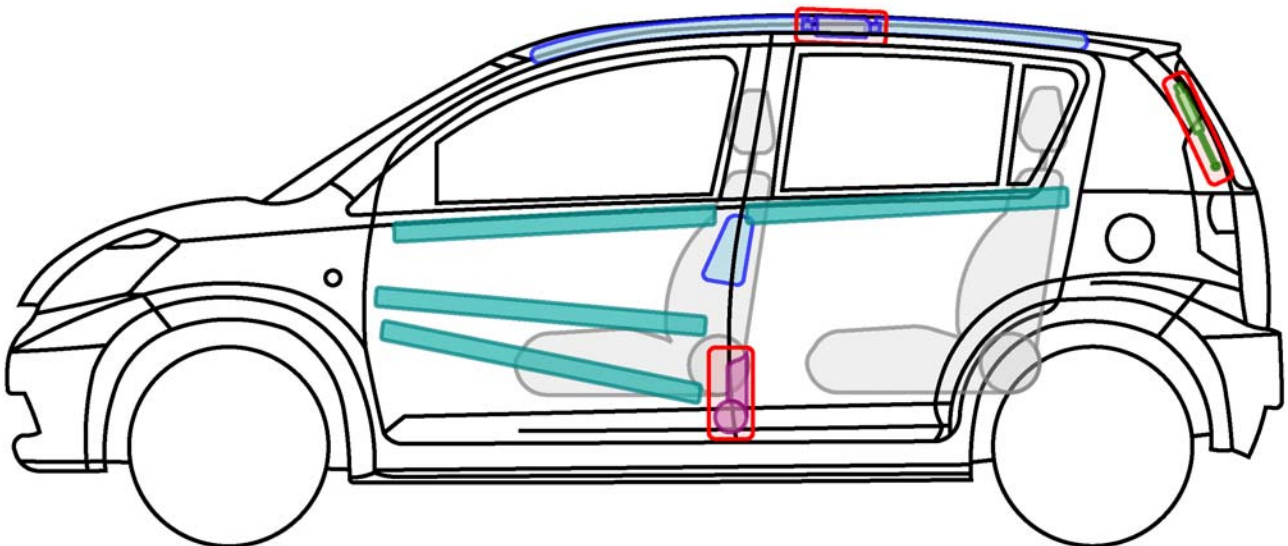
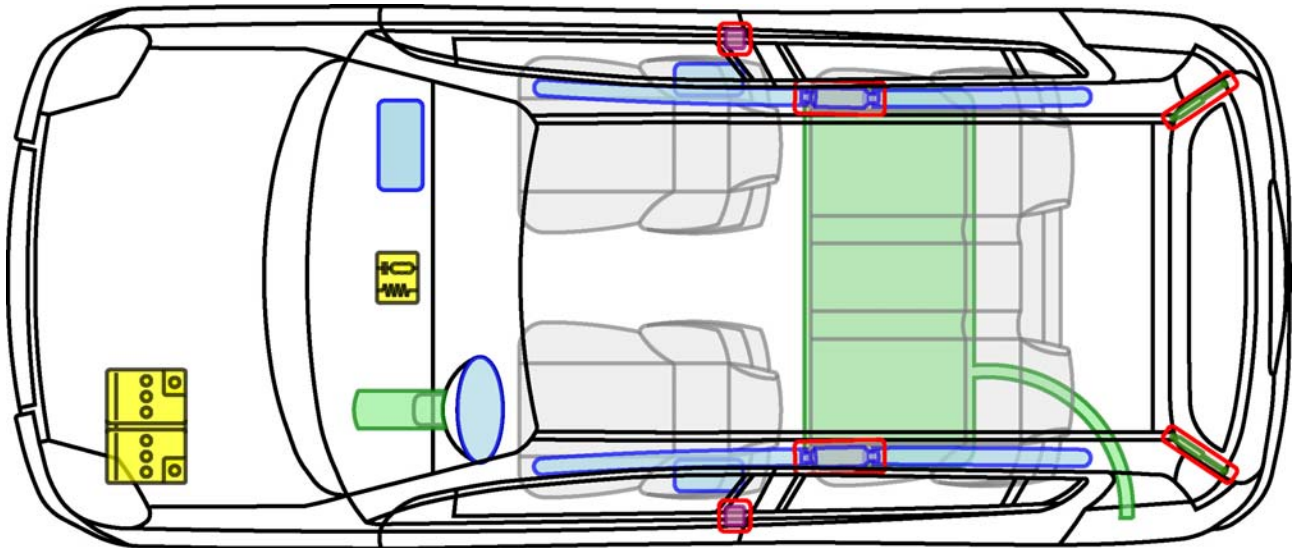

Ja! Daher oben beschriebene Vorgehensweise einhalten.

Wird diese Gefahr gegebenenfalls durch Sitzbelegungserkennungen vermindert?

SUBARU-Fahrzeuge sind zur Zeit mit diesen Systemen nicht ausgestattet.

SUBARU: Justy
 Typ: M3
 Karosserievariante ab 2008



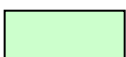





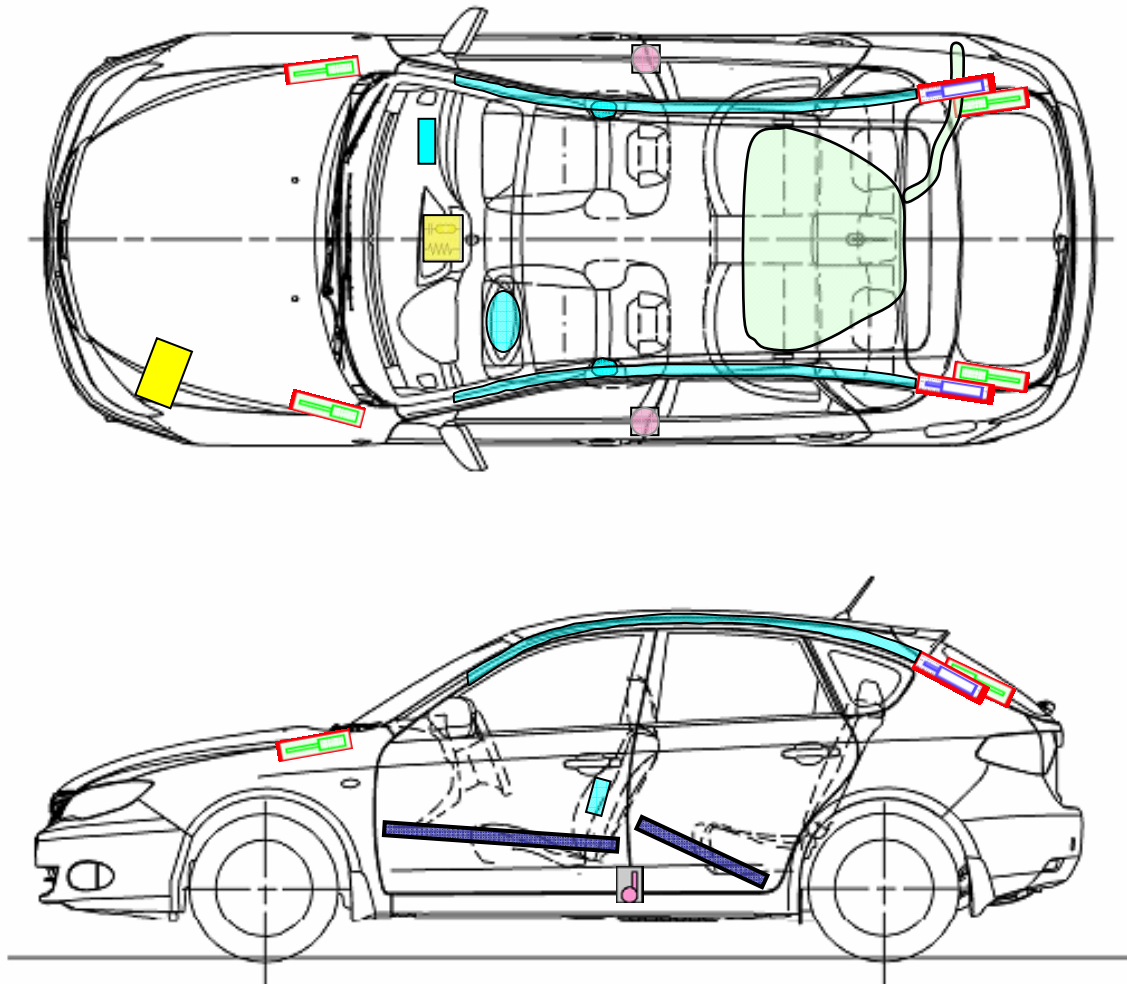

Airbag Modul		Karosserieverstärkung		Airbag Kontrollmodul	
Fensterairbag Gasgenerator				Batterie	
Gurtstraffer		Hauben & Heckklappendämpfer		Kraftstofftank	

Warnhinweise

Nach dem Abklemmen der Batterie 30 Sekunden warten.

SUBARU: Impreza
 Typ: G3
 Karosserievariante ab MJ 2008









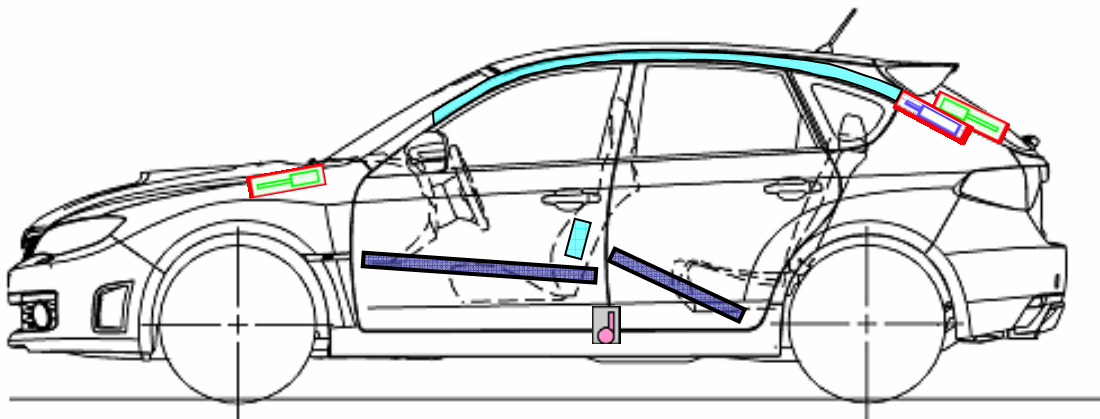
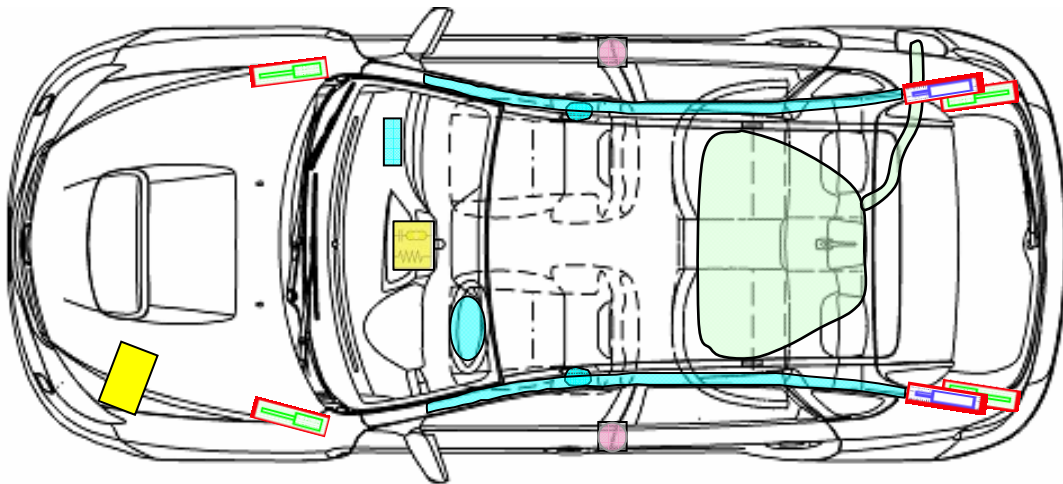

Airbag Module		Karosserieverstärkungen		Airbag Kontrollmodul	
Fensterairbag Gasgenerator				Batterie	
Gurtstraffer		Hauben & Heckklappendämpfer		Kraftstofftank	

Warnhinweise

Nach dem Abklemmen der Batterie 30 Sekunden warten.

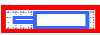
SUBARU: Impreza STI
 Typ: G3
 Karosserievariante ab MJ 2008



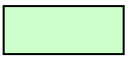





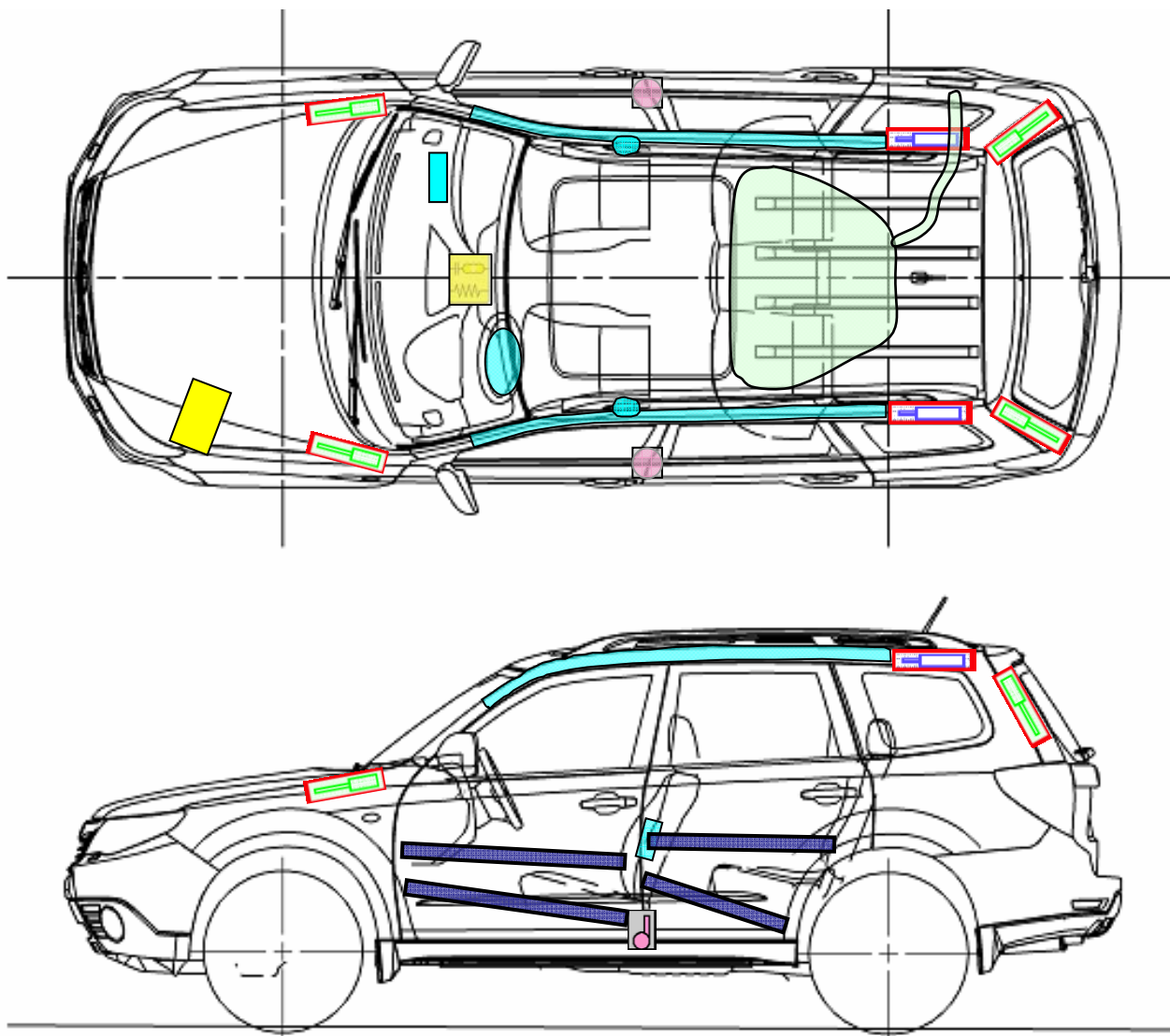

Airbag Modul		Karosserieverstärkungen		Airbag Kontrollmodul	
Fensterairbag Gasgenerator				Batterie	
Gurtstraffer		Hauben & Heckklappendämpfer		Kraftstofftank	

Warnhinweise

Nach dem Abklemmen der Batterie 30 Sekunden warten.

SUBARU: Forester
 Typ: SH / SHS
 Karosserievariante ab MJ 2009



Airbag Modul		Karosserieverstärkungen		Airbag Kontrollmodul	
Fensterairbag Gasgenerator				Batterie	
Gurtstraffer		Hauben & Heckklappendämpfer		Kraftstofftank	

Warnhinweise

Nach dem Abklemmen der Batterie 30 Sekunden warten.



SUBARU

Rettungskarte

SUBARU: Legacy
Typ: BL/BP
BL/BPS
Karosserievariante: MJ 2004 bis MJ 2009

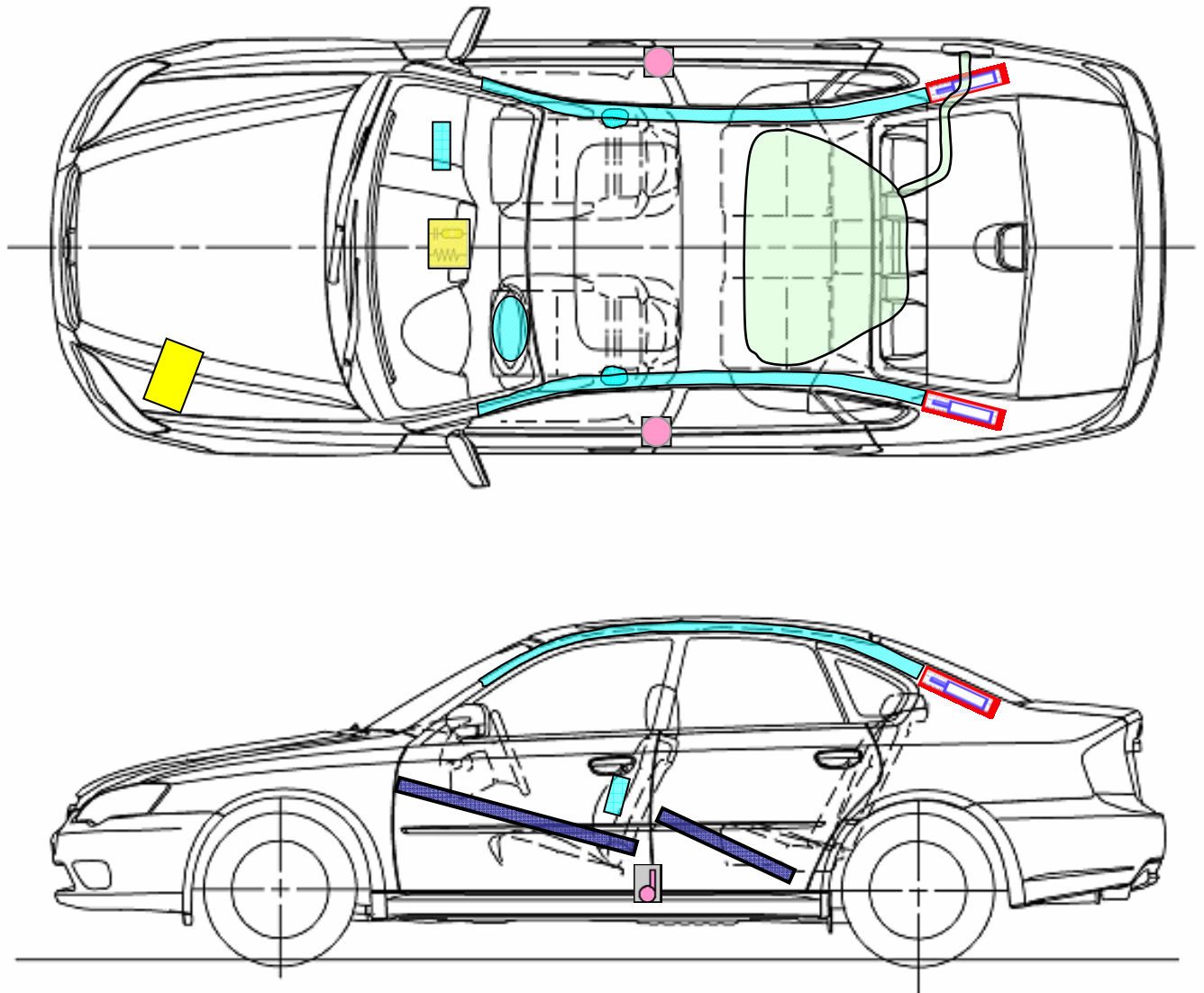

Airbag Modul		Karosserieverstärkung		Airbag Kontrollmodul	
Fensterairbag Gasgenerator				Batterie	
Gurtstraffer		Hauben & Heckklappendämpfer		Kraftstofftank	

Warnhinweise

Nach dem Abklemmen der Batterie 30 Sekunden warten.



SUBARU

Rettenungskarte

SUBARU: Legacy
Typ: BL/BP
BL/BPS
Karosserieversion MJ 2004 bis MJ 2009

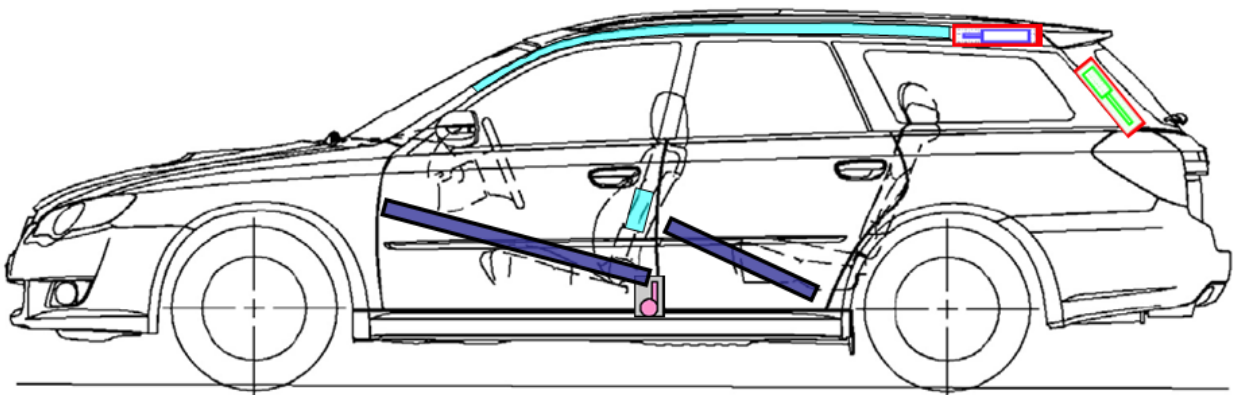
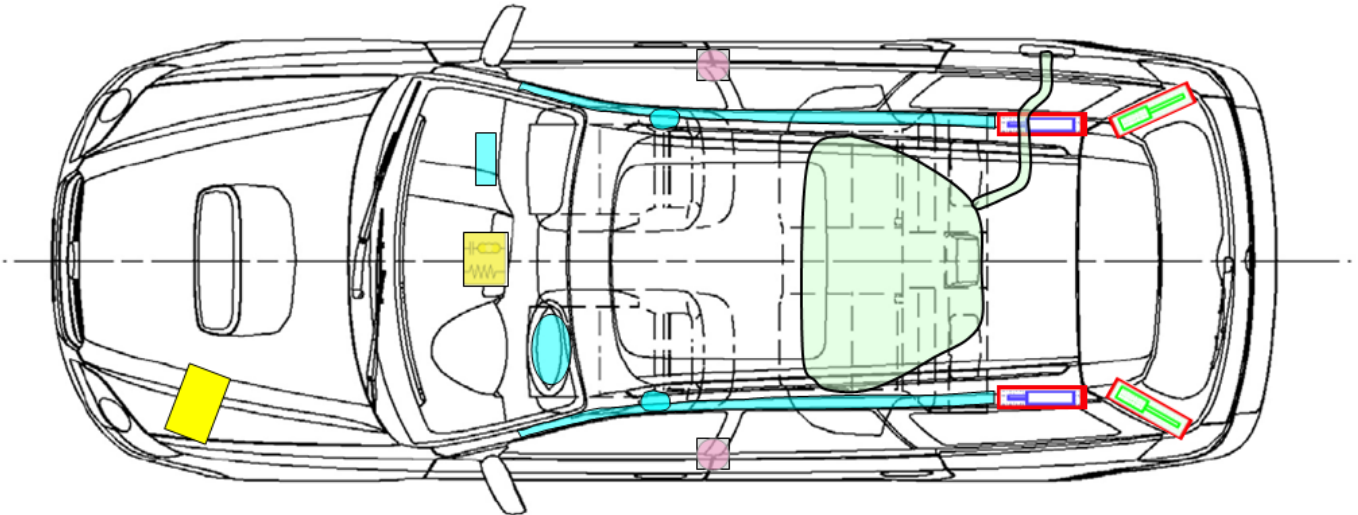







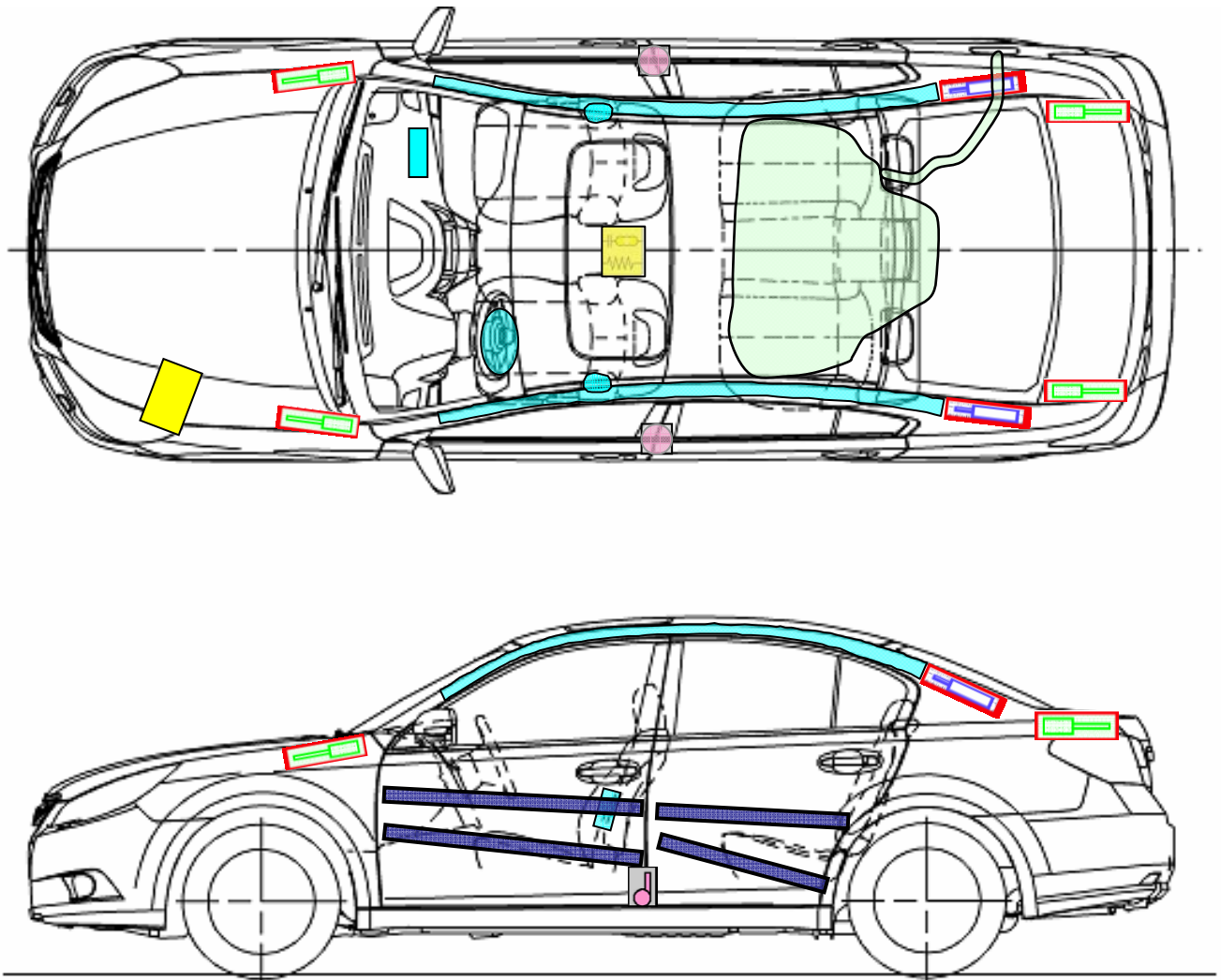

Airbag Modul		Karosserieverstärkungen		Airbag Kontrollmodul	
Fensterairbag Gasgenerator				Batterie	
Gurtstraffer		Hauben & Heckklappendämpfer		Kraftstofftank	

Warnhinweise

Nach dem Abklemmen der Batterie 30 Sekunden warten.

SUBARU: Legacy
 Typ: BM/BR
 BM/BRS
 Karosserievariante ab MJ 2010









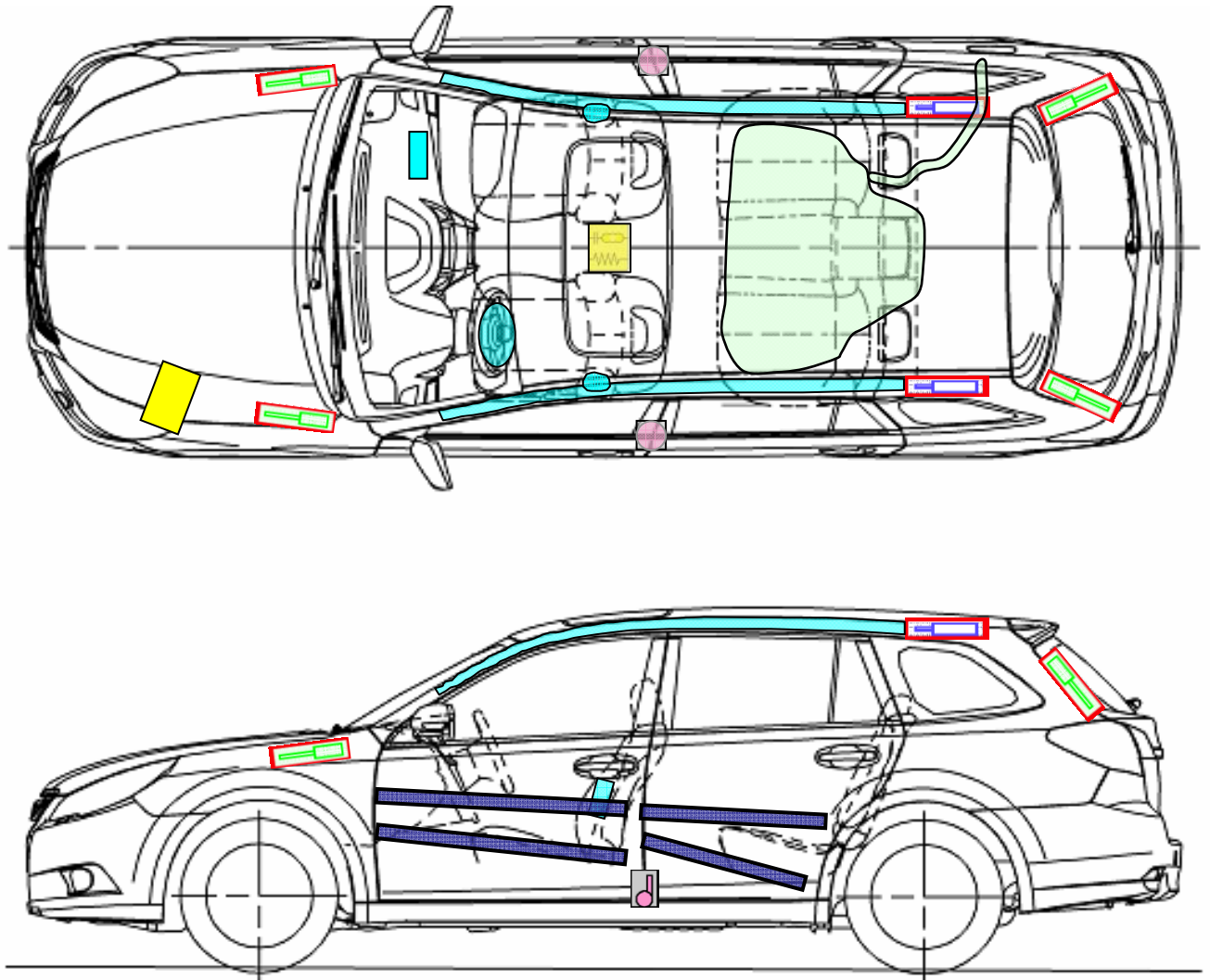

Airbag Modul		Karosserieverstärkungen		Airbag Kontrollmodul	
Fensterairbag Gasgenerator				Batterie	
Gurtstraffer		Hauben & Heckklappendämpfer		Kraftstofftank	

Warnhinweise

Nach dem Abklemmen der Batterie 30 Sekunden warten.

SUBARU: Legacy
 Typ: BM/BR
 BM/BRS
 Karosserievariante ab MJ 2010



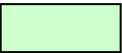





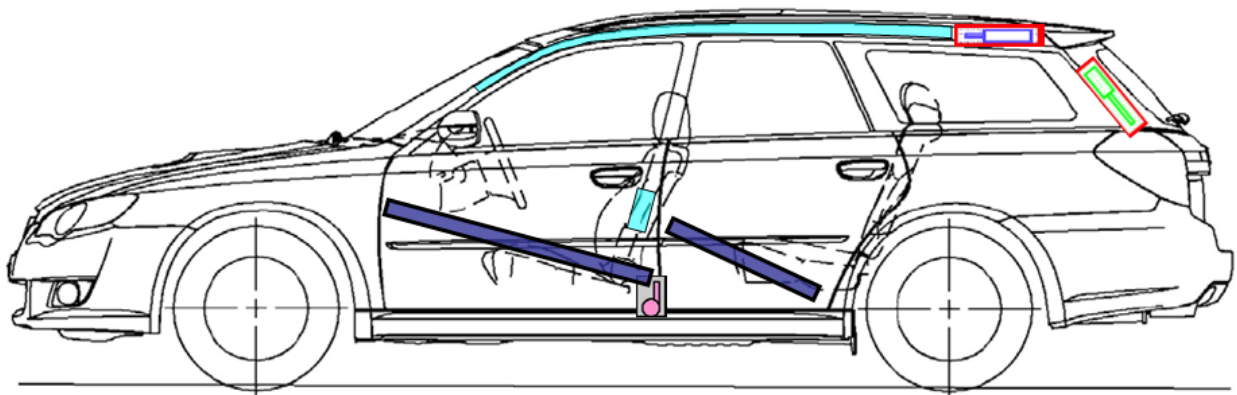
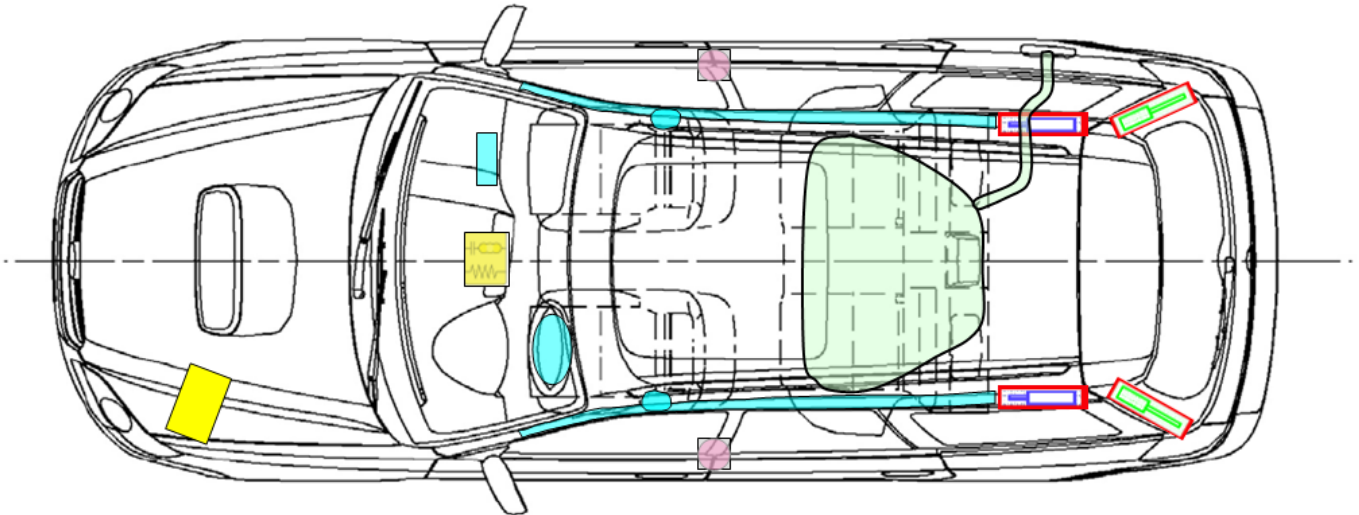

Airbag Modul		Karosserieverstärkung		Airbag Kontrollmodul	
Fensterairbag Gasgenerator				Batterie	
Gurtstraffer		Hauben & Heckklappendämpfer		Kraftstofftank	

Warnhinweise

Nach dem Abklemmen der Batterie 30 Sekunden warten.

SUBARU: Outback
 Typ: BL/BP
 BL/BPS
 Karosserieversion MJ 2004 bis MJ 2009



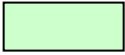





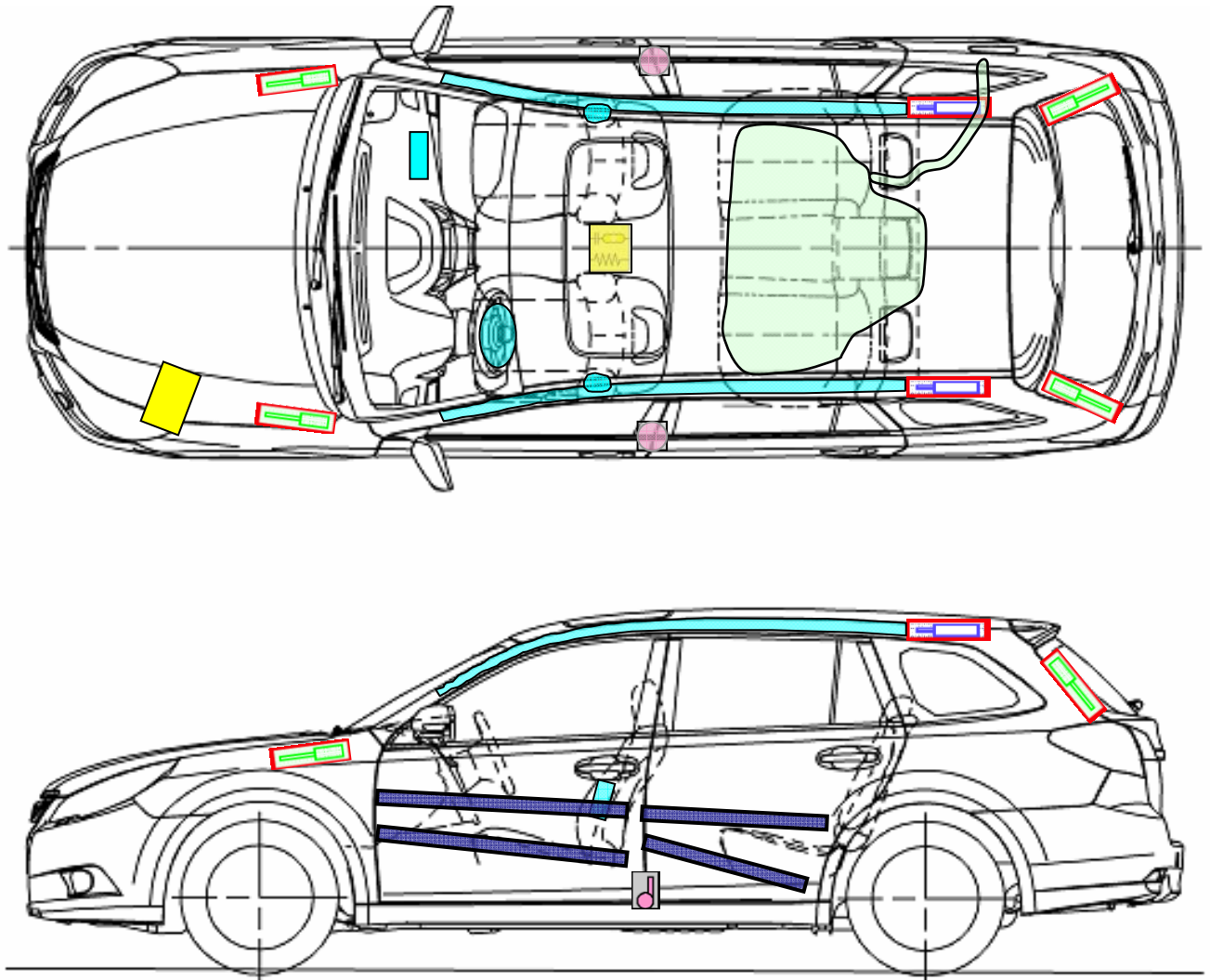

Airbag Modul		Karosserieverstärkungen		Airbag Kontrollmodul	
Fensterairbag Gasgenerator				Batterie	
Gurtstraffer		Hauben & Heckklappendämpfer		Kraftstofftank	

Warnhinweise

Nach dem Abklemmen der Batterie 30 Sekunden warten.

SUBARU: Outback
 Typ: BM/BR
 BM/BRS
 Karosserievariante ab MJ 2010



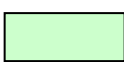





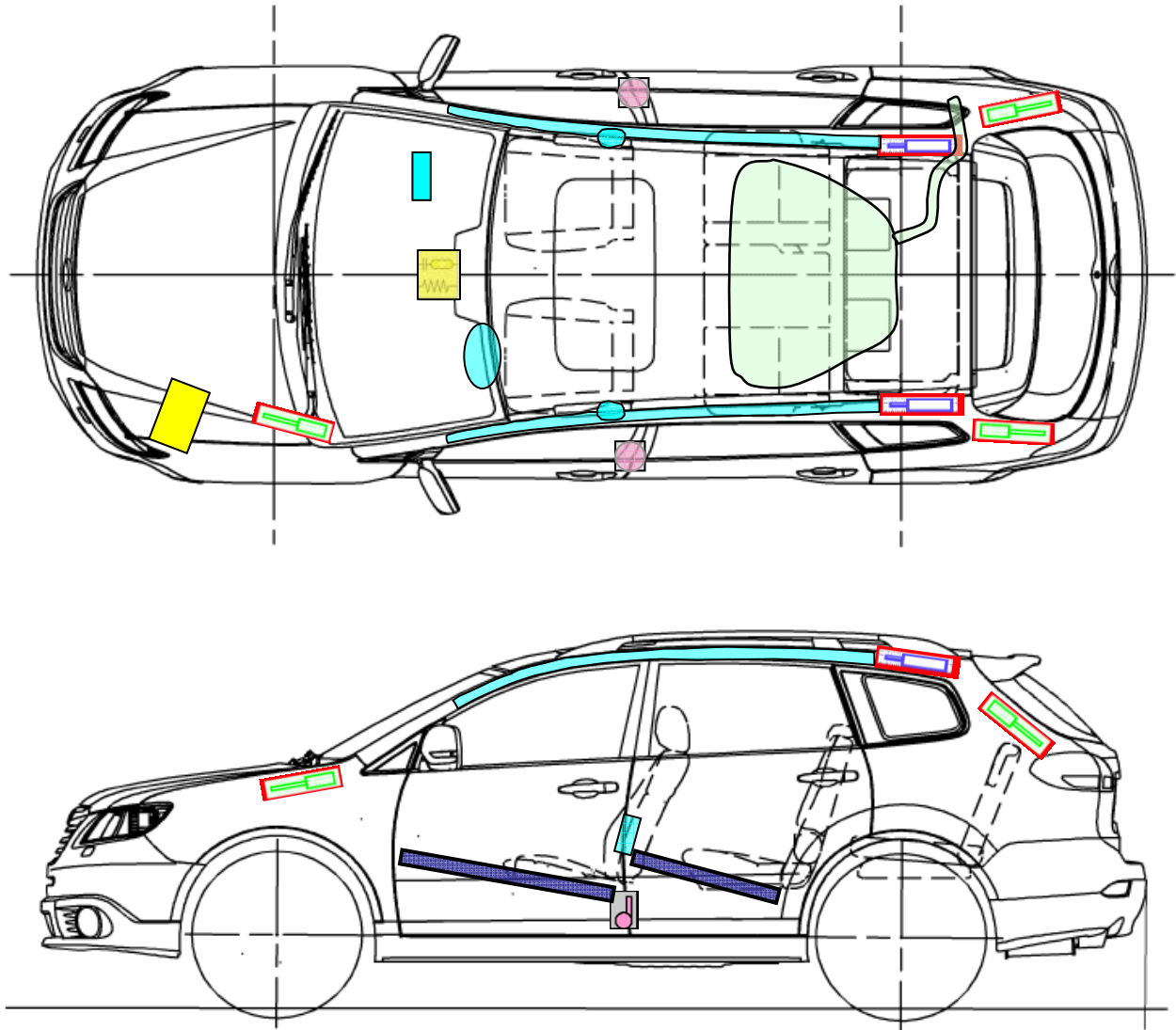

Airbag Modul		Karosserieverstärkung		Airbag Kontrollmodul	
Fensterairbag Gasgenerator				Batterie	
Gurtstraffer		Hauben & Heckklappendämpfer		Kraftstofftank	

Warnhinweise

Nach dem Abklemmen der Batterie 30 Sekunden warten.

SUBARU: Tribeca
 Typ: WX
 Karosserievariante ab MJ 2008









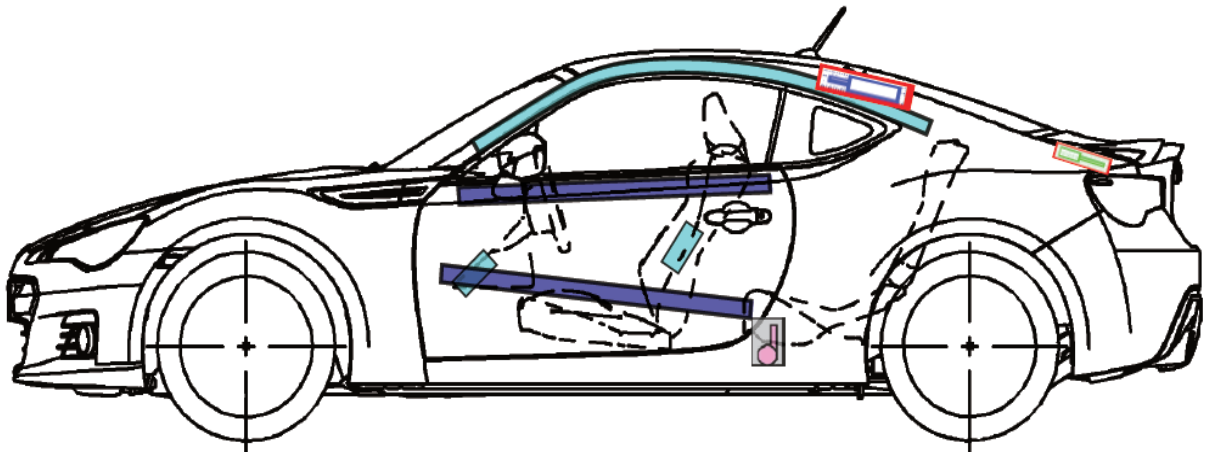
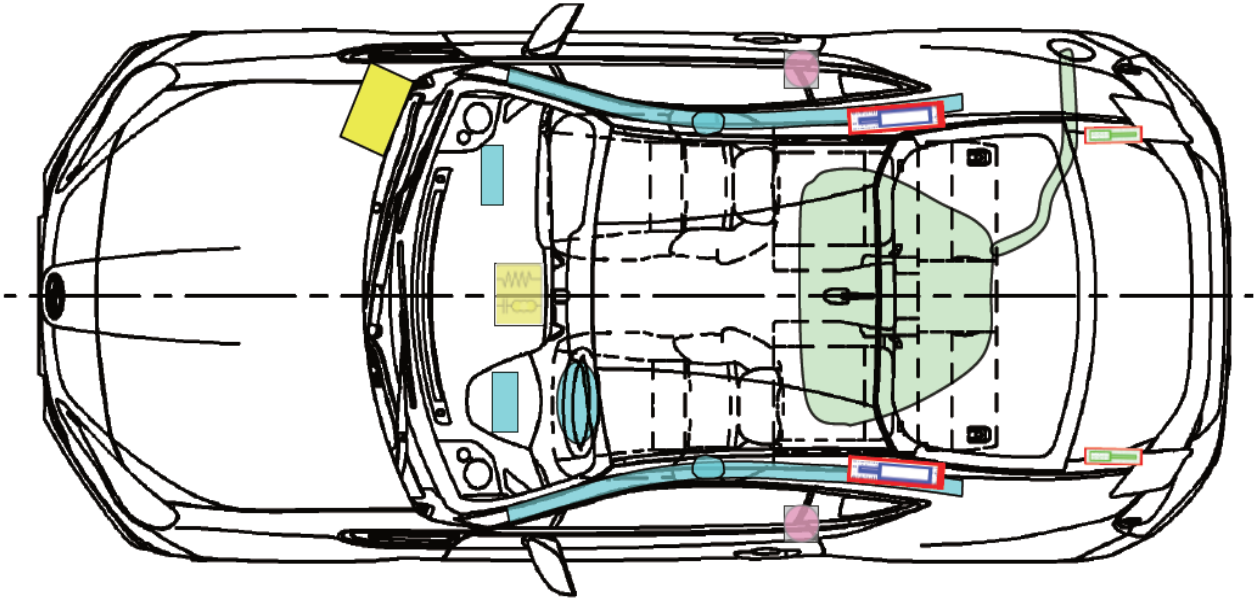

Airbag Modul		Karosserieverstärkungen		Airbag Kontrollmodul	
Fensterairbag Gasgenerator				Batterie	
Gurtstraffer		Hauben & Heckklappendämpfer		Kraftstofftank	

Warnhinweise

Nach dem Abklemmen der Batterie 30 Sekunden warten.

SUBARU: BRZ
 Typ: ZC
 Karosserieversion ab MJ 2013









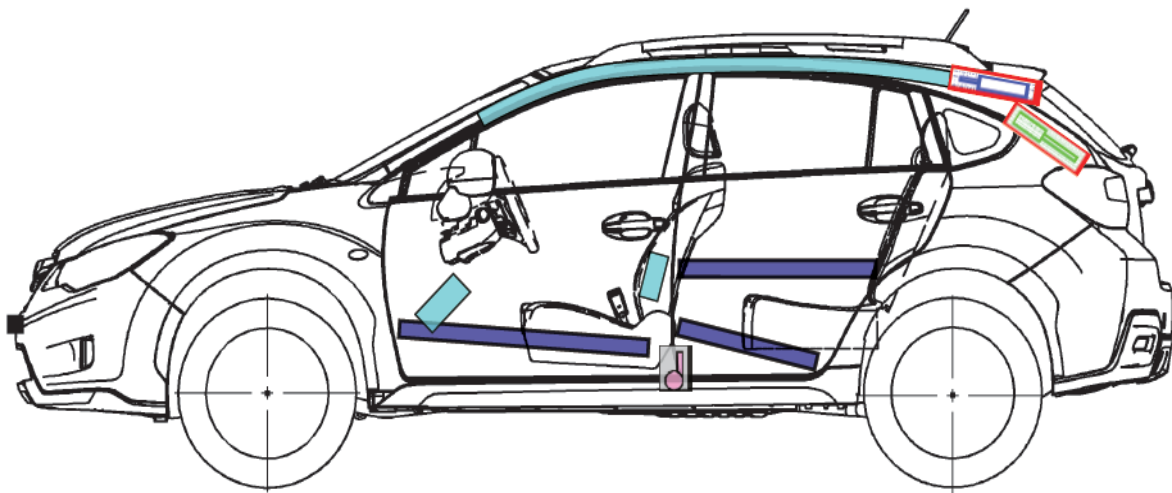
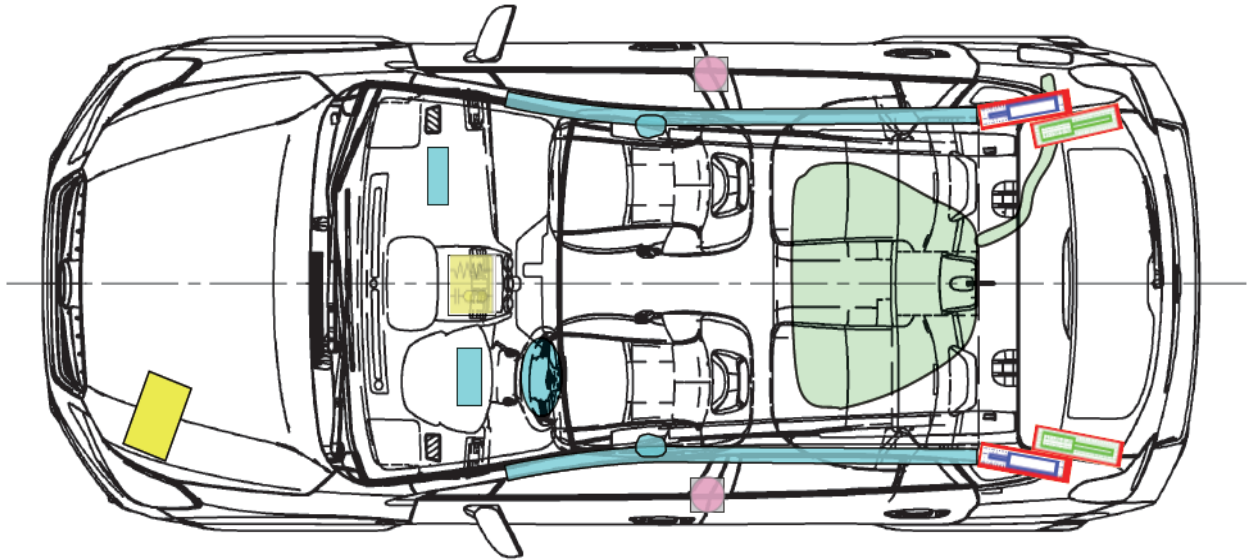

Airbag Modul		Karosserieverstärkungen		Airbag Kontrollmodul	
Fensterairbag Gasgenerator				Batterie	
Gurtstraffer		Hauben & Heckklappendämpfer		Kraftstofftank	

Warnhinweise

Nach dem Abklemmen der Batterie 30 Sekunden warten.

SUBARU: XV
 Typ: G4
 Karosserieversion ab MJ 2012



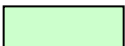





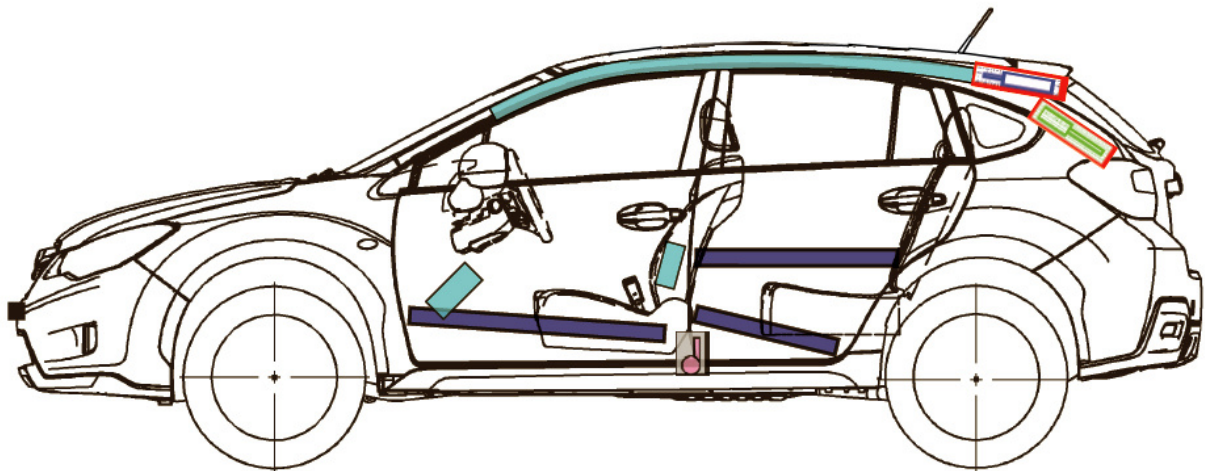
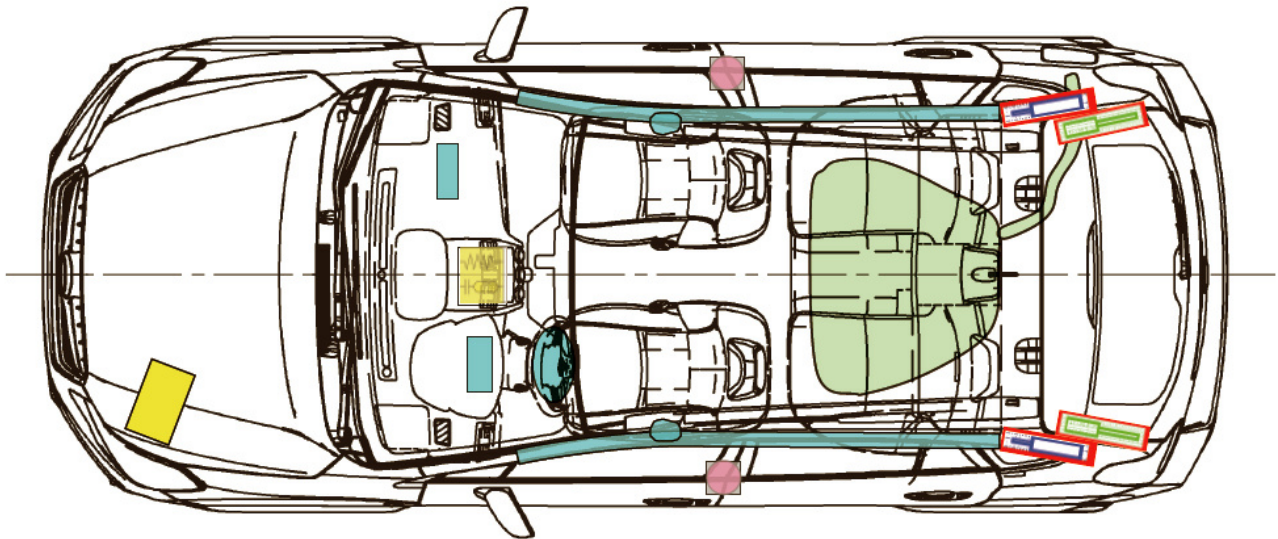

Airbag Modul		Karosserieverstärkungen		Airbag Kontrollmodul	
Fensterairbag Gasgenerator				Batterie	
Gurtstraffer		Hauben & Heckklappendämpfer		Kraftstofftank	

Warnhinweise

Nach dem Abklemmen der Batterie 30 Sekunden warten.

SUBARU: Impreza
 Typ: G4
 Karosserieversion ab MJ 2012









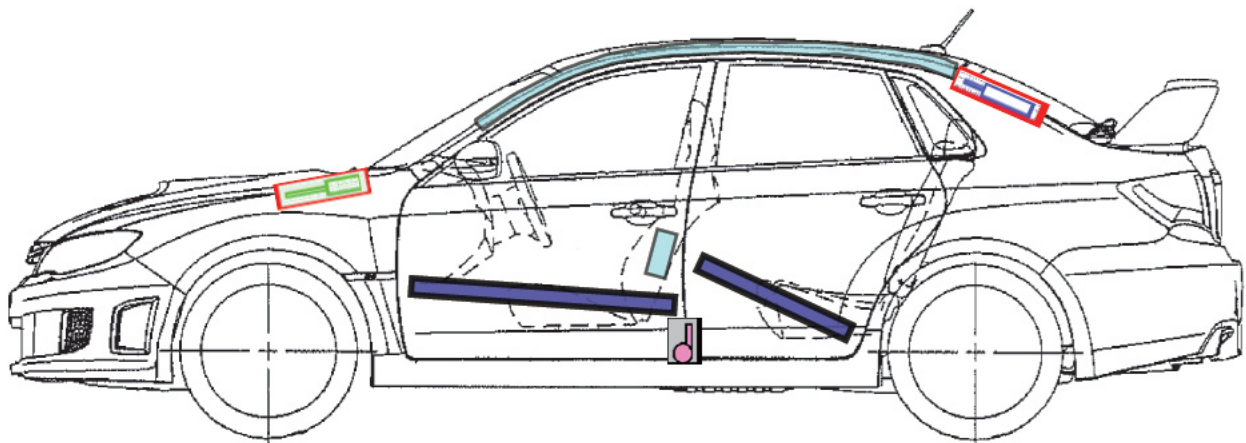
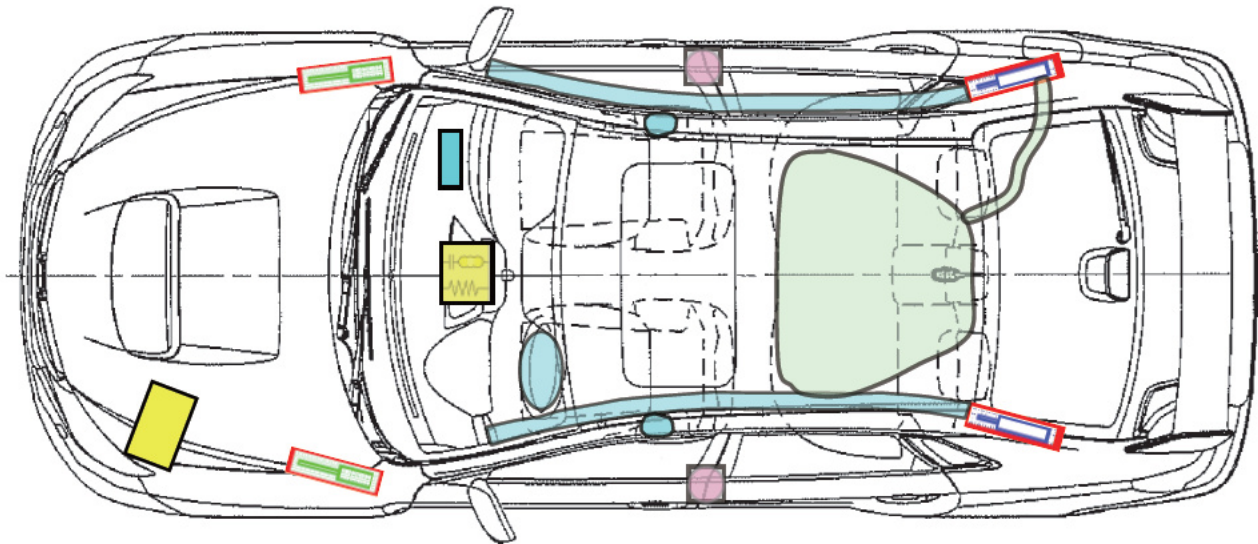

Airbag Modul		Karosserieverstärkungen		Airbag Kontrollmodul	
Fensterairbag Gasgenerator				Batterie	
Gurtstraffer		Hauben & Heckklappendämpfer		Kraftstofftank	

Warnhinweise

Nach dem Abklemmen der Batterie 30 Sekunden warten.

SUBARU: Impreza STI
 Typ: GVF
 Karosserievariante ab MJ 2010









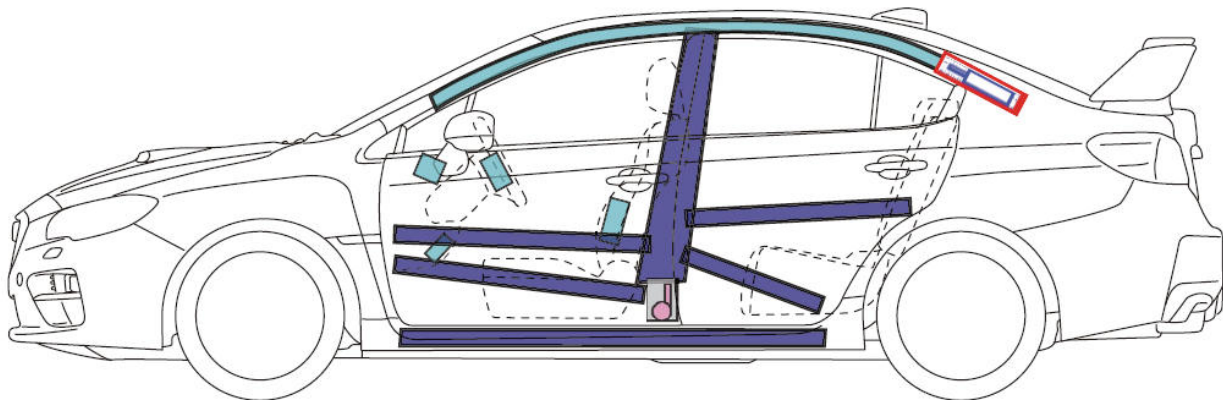
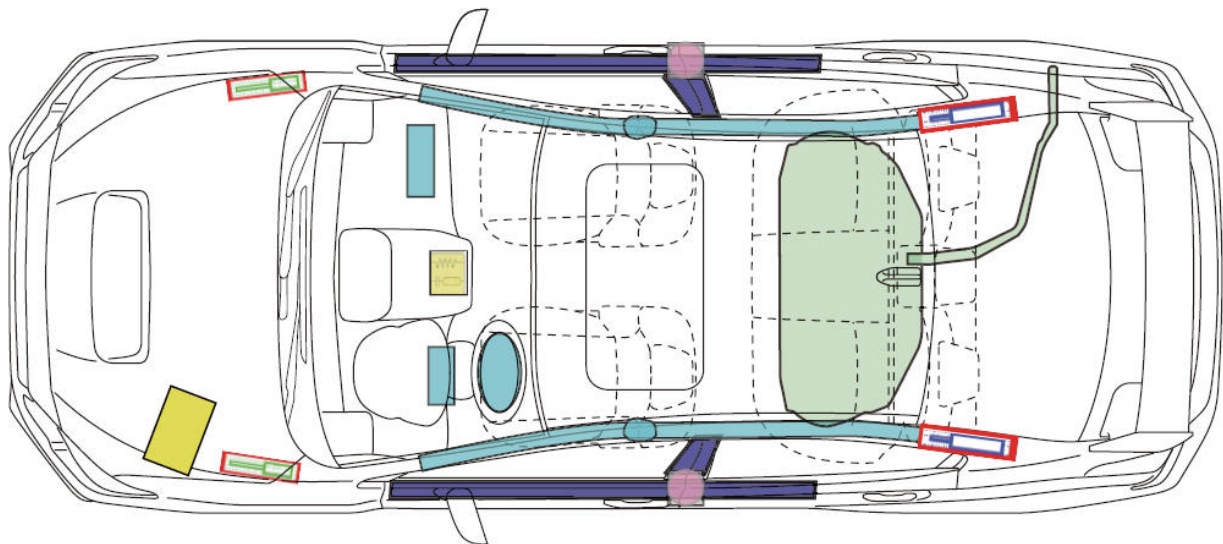

Airbag Modul		Karosserieverstärkungen		Airbag Kontrollmodul	
Fensterairbag Gasgenerator				Batterie	
Gurtstraffer		Hauben & Heckklappendämpfer		Kraftstofftank	

Warnhinweise

Nach dem Abklemmen der Batterie 30 Sekunden warten.

SUBARU: WRX STI
 Typ: V1
 Karosserievariante ab MJ 2015



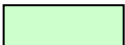





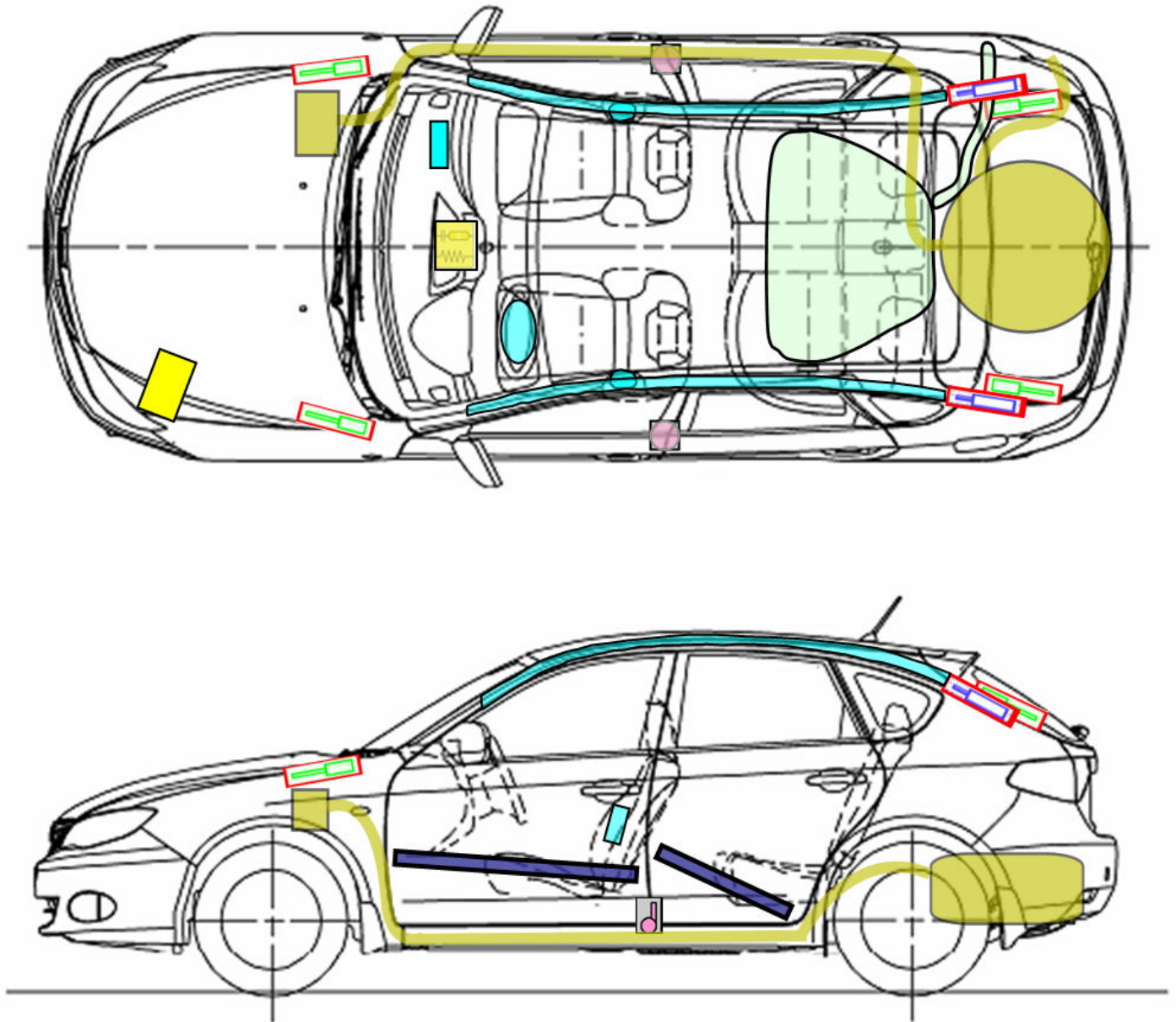

Airbag Modul		Karosserieverstärkungen		Airbag Kontrollmodul	
Fensterairbag Gasgenerator				Batterie	
Gurtstraffer		Hauben & Heckklappendämpfer		Kraftstofftank	

Warnhinweise

Nach dem Abklemmen der Batterie 30 Sekunden warten.

SUBARU: Impreza
 Typ: G3
 Karosserievariante ab MJ 2008



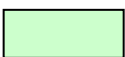





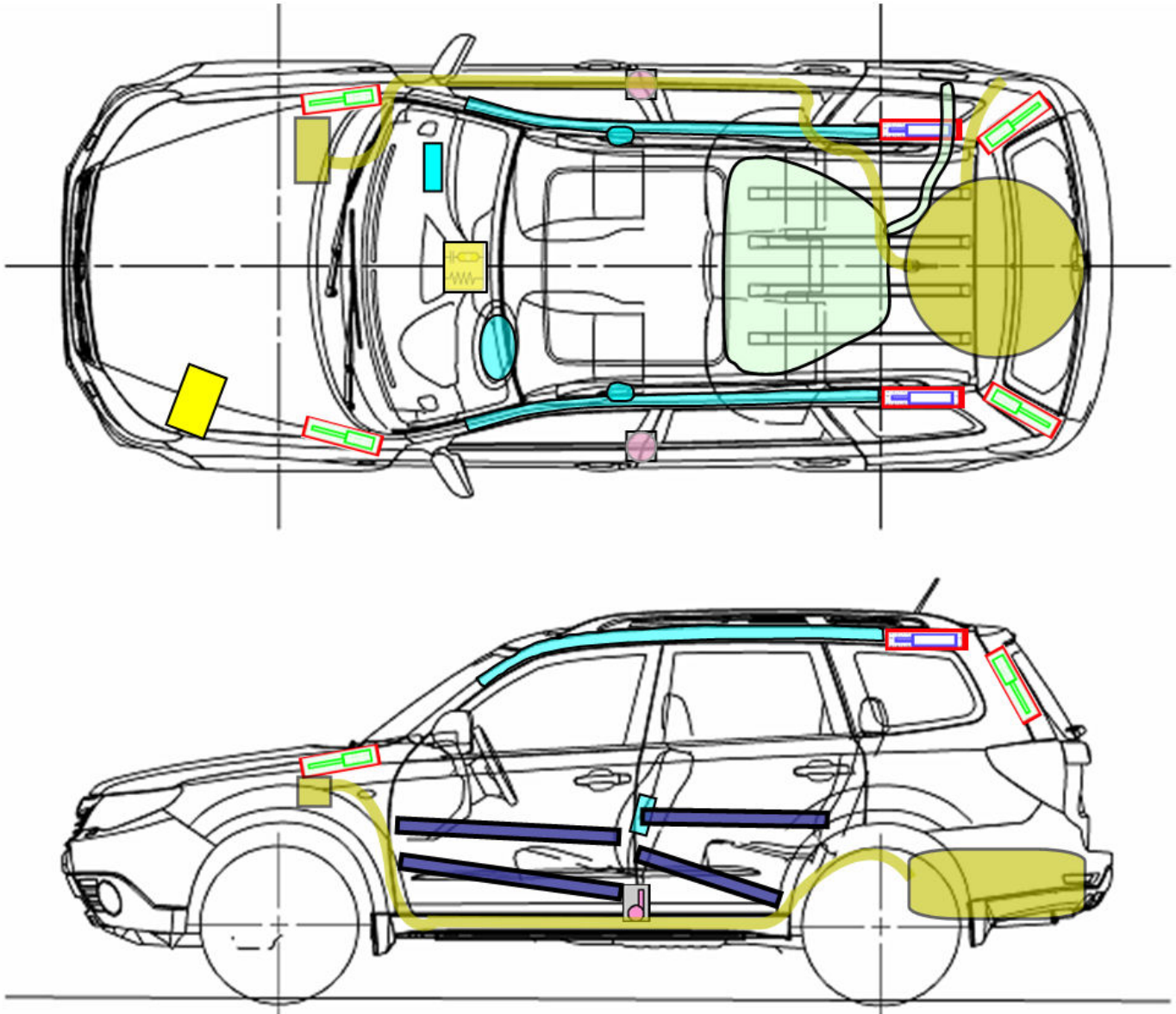

Airbag Module		Karosserieverstärkungen		Airbag Kontrollmodul	
Fensterairbag Gasgenerator		Autogasanlage		Batterie	
Gurtstraffer		Hauben & Heckklappendämpfer		Kraftstofftank	

Warnhinweise

Nach dem Abklemmen der Batterie 30 Sekunden warten.

SUBARU: Forester
 Typ: SH / SHS
 Karosserievariante ab MJ 2009

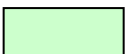

Airbag Modul		Karosserieverstärkungen		Airbag Kontrollmodul	
Fensterairbag Gasgenerator		Autogasanlage		Batterie	
Gurtstraffer		Hauben & Heckklappendämpfer		Kraftstofftank	

Warnhinweise

Nach dem Abklemmen der Batterie 30 Sekunden warten.









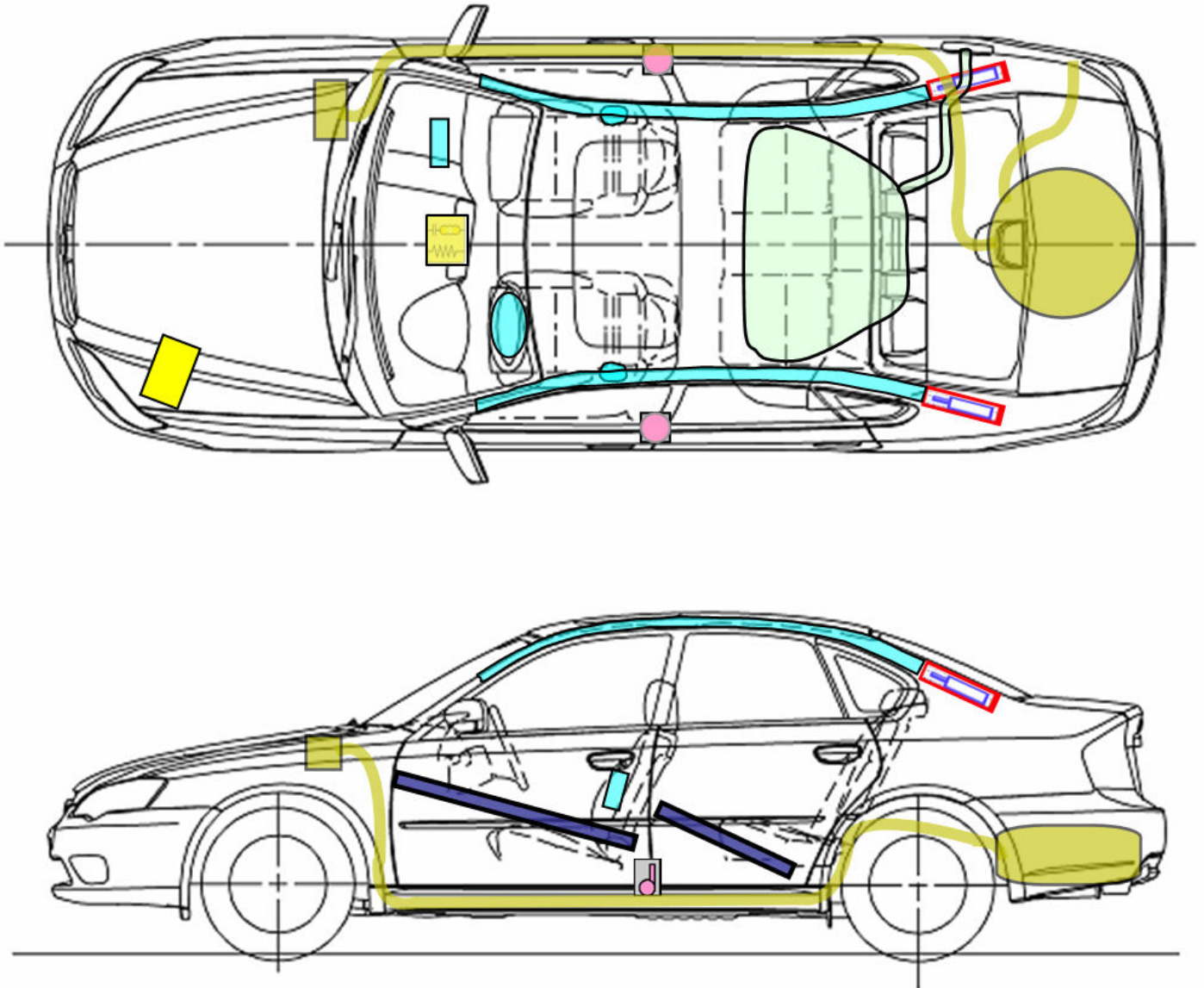

SUBARU

Rettungskarte

SUBARU: Legacy
Typ: BL/BP
BL/BPS
Karosserievariante: MJ 2004 bis MJ 2009

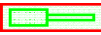

Airbag Modul		Karosserieverstärkung		Airbag Kontrollmodul	
Fensterairbag Gasgenerator		Autogasanlage		Batterie	
Gurtstraffer		Hauben & Heckklappendämpfer		Kraftstofftank	

Warnhinweise

Nach dem Abklemmen der Batterie 30 Sekunden warten.



SUBARU

Rettungskarte

SUBARU: Legacy
Typ: BL/BP
BL/BPS
Karosserieversion MJ 2004 bis MJ 2009

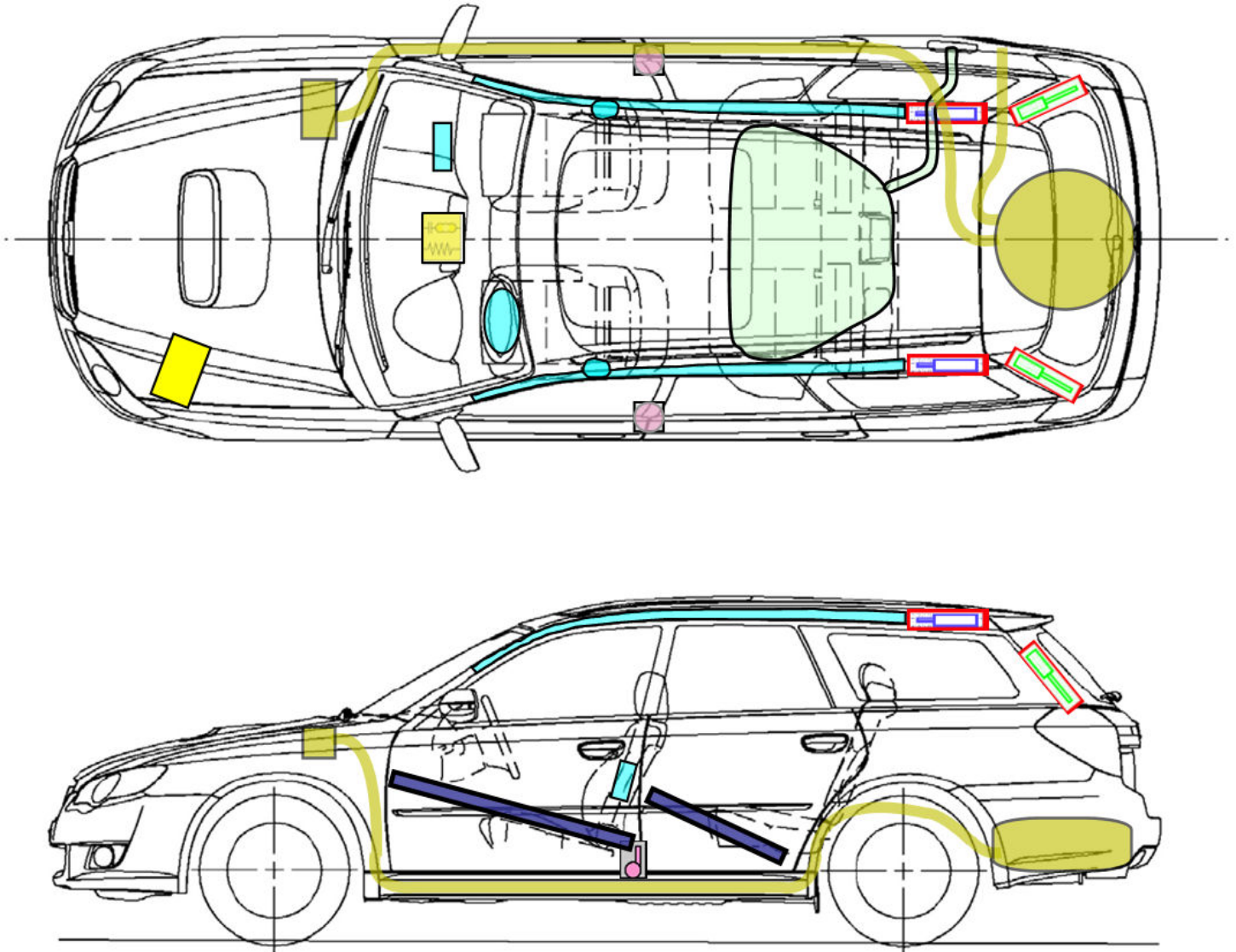

Airbag Modul		Karosserieverstärkungen		Airbag Kontrollmodul	
Fensterairbag Gasgenerator		Autogasanlage		Batterie	
Gurtstraffer		Hauben & Heckklappendämpfer		Kraftstofftank	

Warnhinweise

Nach dem Abklemmen der Batterie 30 Sekunden warten.



SUBARU

Rettungskarte

SUBARU: Outback
Typ: BL/BP
BL/BPS
Karosserieversion MJ 2004 bis MJ 2009

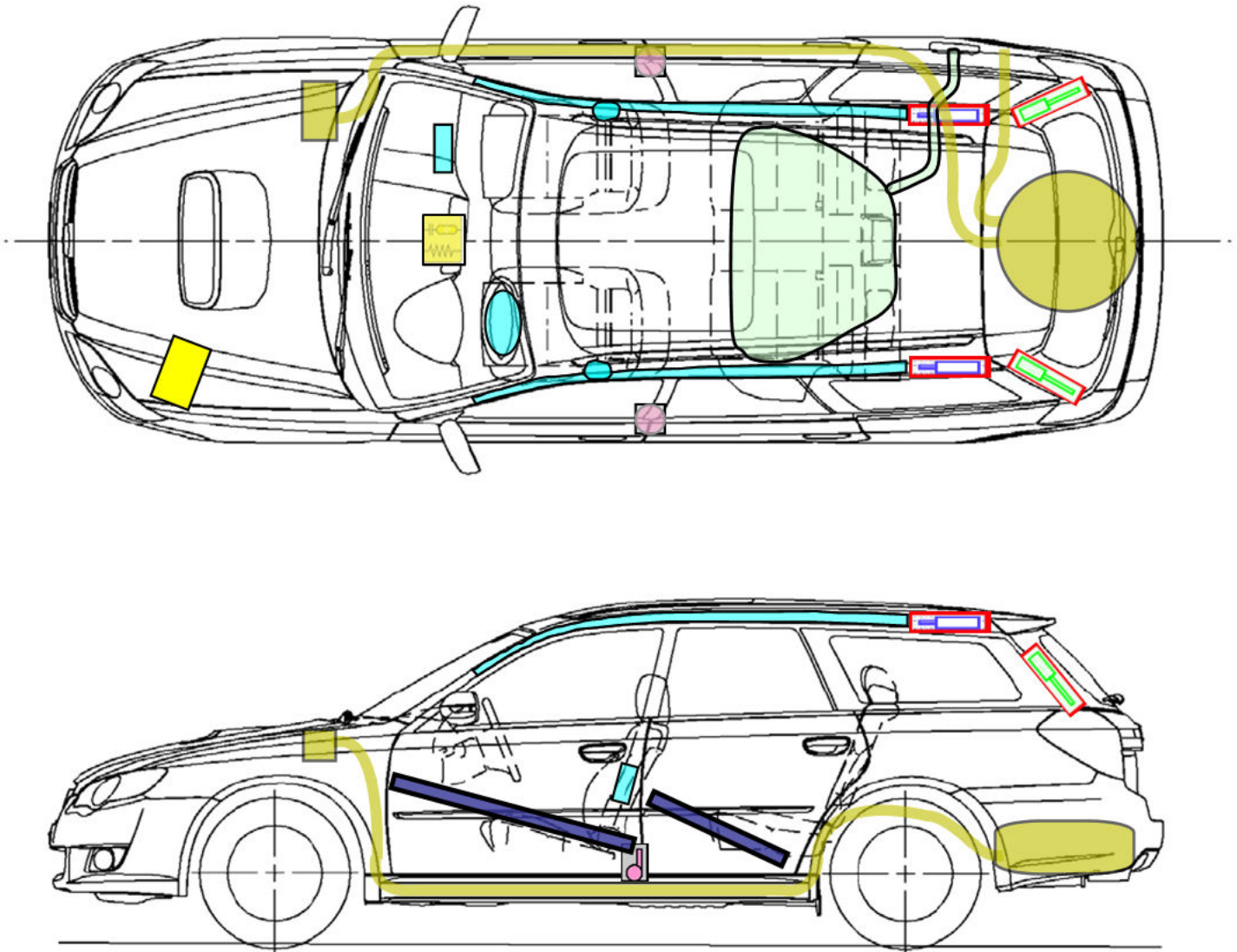









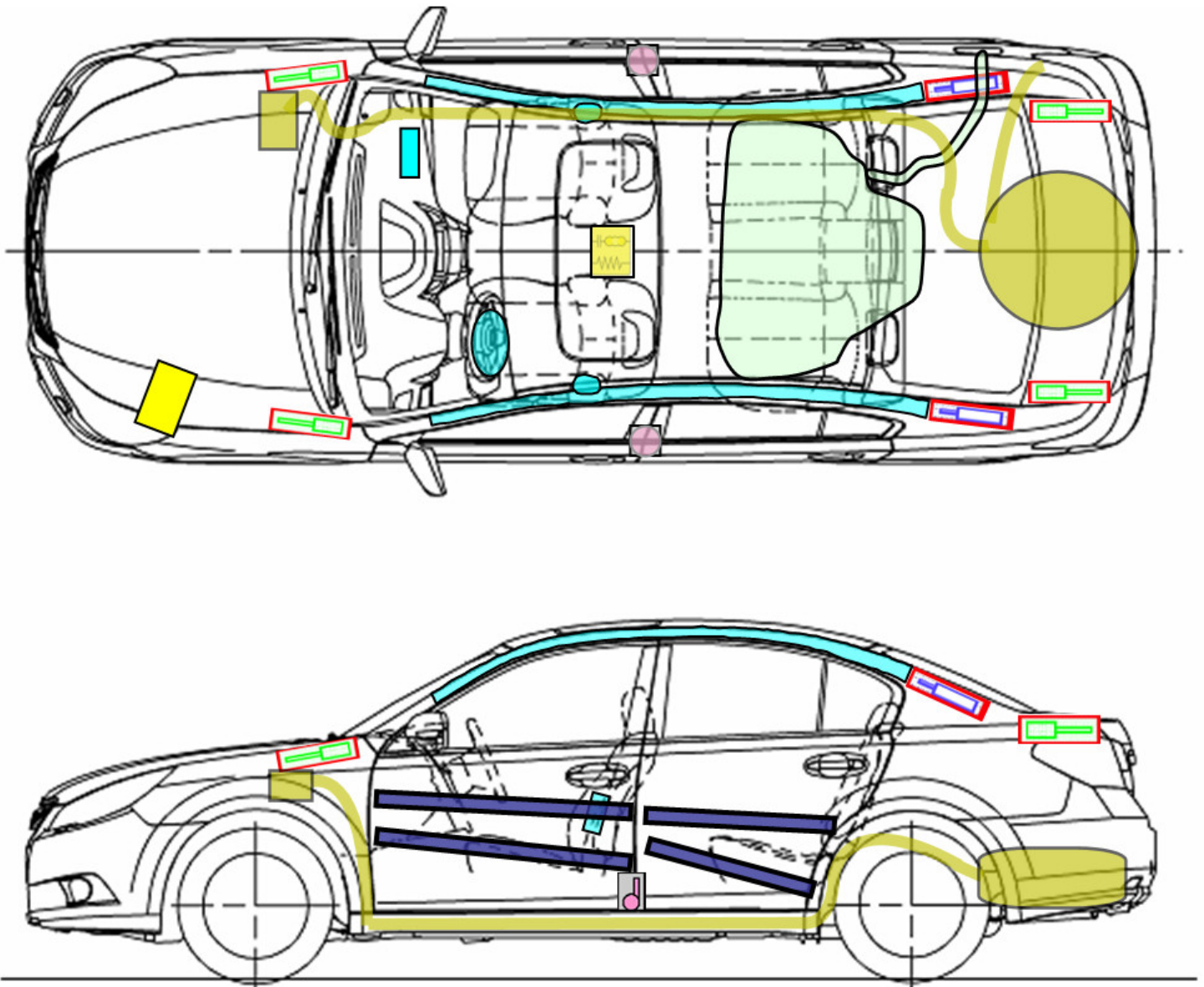

Airbag Modul		Karosserieverstärkungen		Airbag Kontrollmodul	
Fensterairbag Gasgenerator		Autogasanlage		Batterie	
Gurtstraffer		Hauben & Heckklappendämpfer		Kraftstofftank	

Warnhinweise

Nach dem Abklemmen der Batterie 30 Sekunden warten.

SUBARU: Legacy Limousine
 Typ: BM/BR
 BM/BRS
 Karosserievariante ab MJ 2010
 Mit ecomatic® Autogasanlage











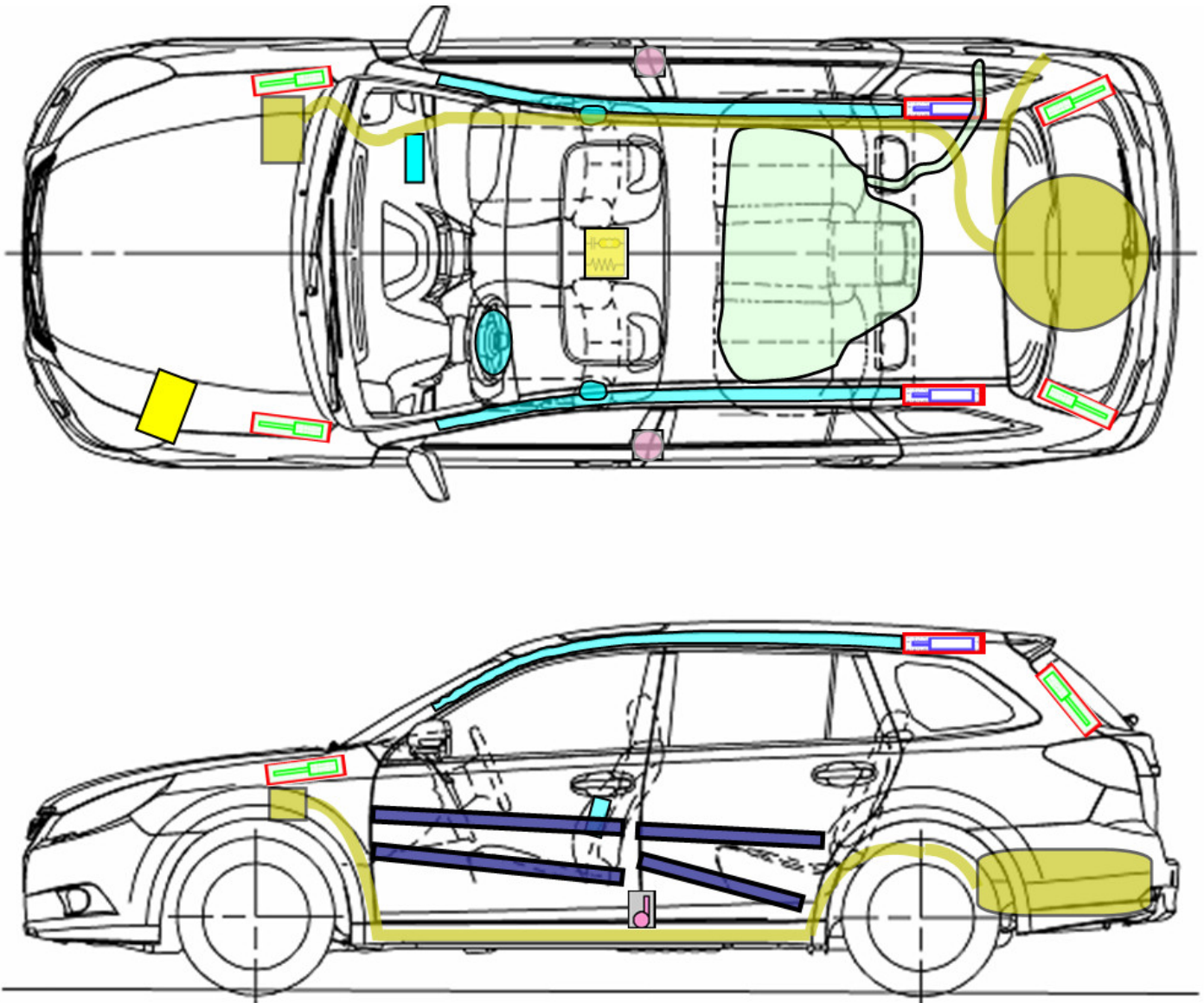

Airbag Modul		Karosserieverstärkungen		Airbag Kontrollmodul	
Fensterairbag Gasgenerator		Autogasanlage		Batterie	
Gurtstraffer		Hauben & Heckklappendämpfer		Kraftstofftank	

Warnhinweise

Nach dem Abklemmen der Batterie 30 Sekunden warten.

SUBARU: Legacy Kombi
 Typ: BM/BR
 BM/BRS
 Karosserievariante ab MJ 2010
 Mit ecomatic® Autogasanlage









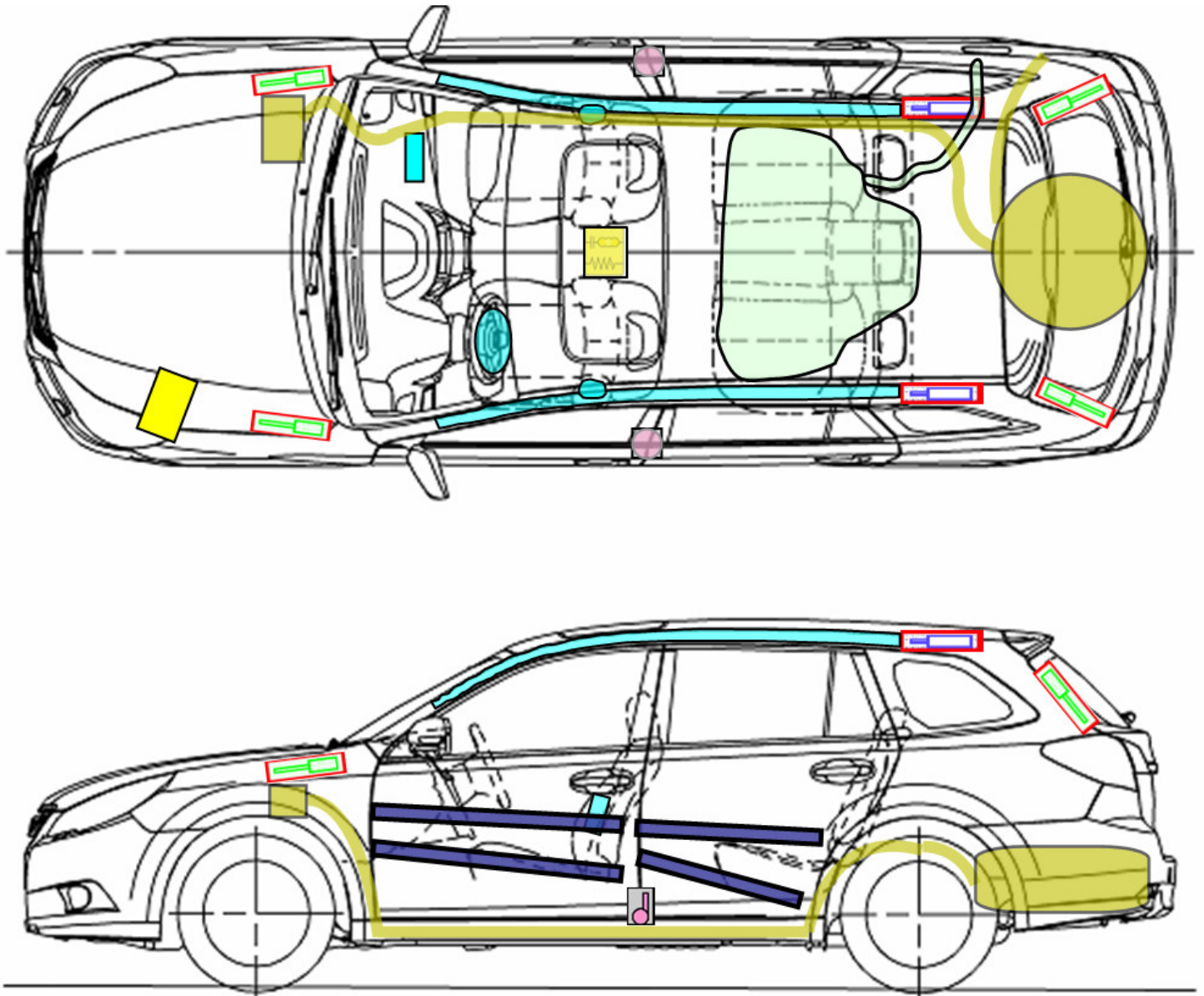

Airbag Modul		Karosserieverstärkung		Airbag Kontrollmodul	
Fensterairbag Gasgenerator		Autogasanlage		Batterie	
Gurtstraffer		Hauben & Heckklappendämpfer		Kraftstofftank	

Warnhinweise

Nach dem Abklemmen der Batterie 30 Sekunden warten.

SUBARU: Outback
 Typ: BM/BR
 BM/BRS
 Karosserievariante ab MJ 2010
 Mit ecomatic® Autogasanlage



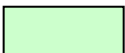





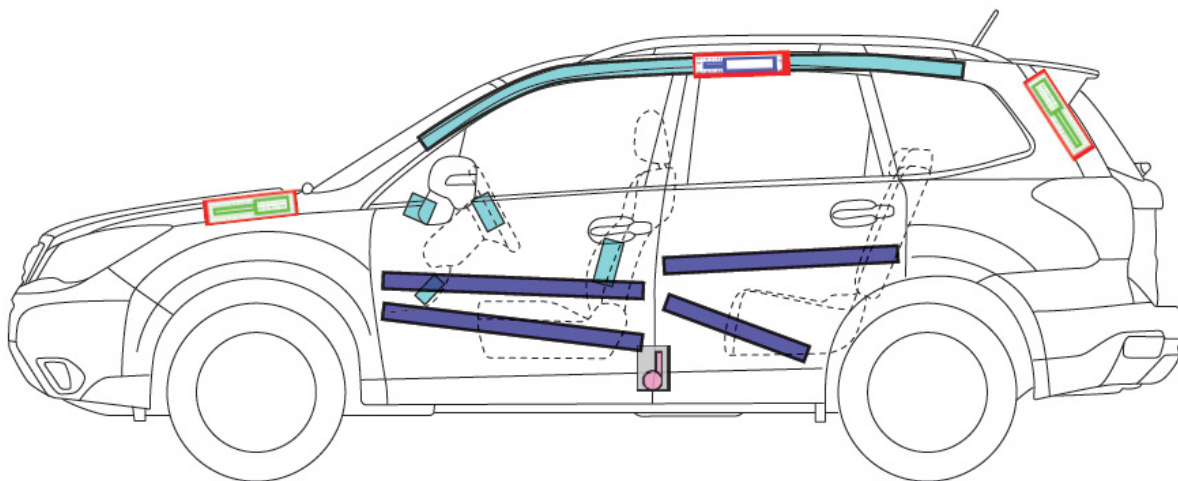
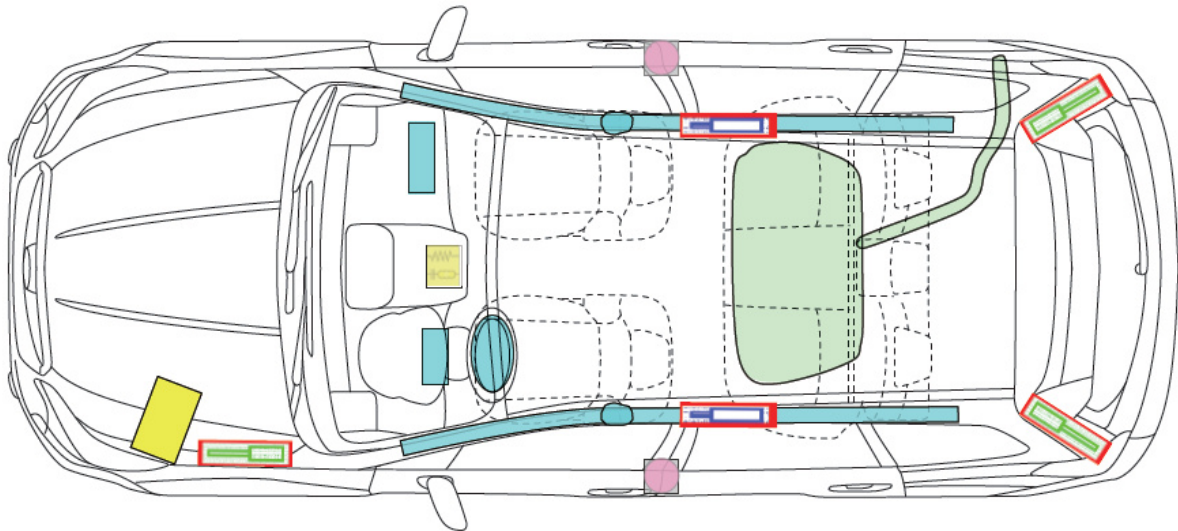

Airbag Modul		Karosserieverstärkung		Airbag Kontrollmodul	
Fensterairbag Gasgenerator		Autogasanlage		Batterie	
Gurtstraffer		Hauben & Heckklappendämpfer		Kraftstofftank	

Warnhinweise

Nach dem Abklemmen der Batterie 30 Sekunden warten.

SUBARU: Forester
 Typ: SJ
 Karosserieversion ab MJ 2013



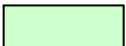





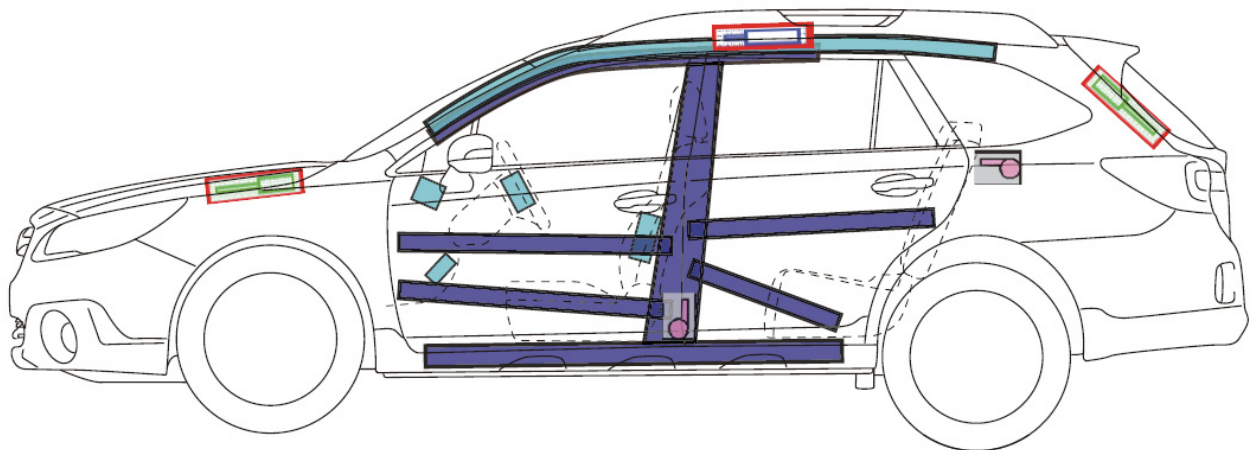
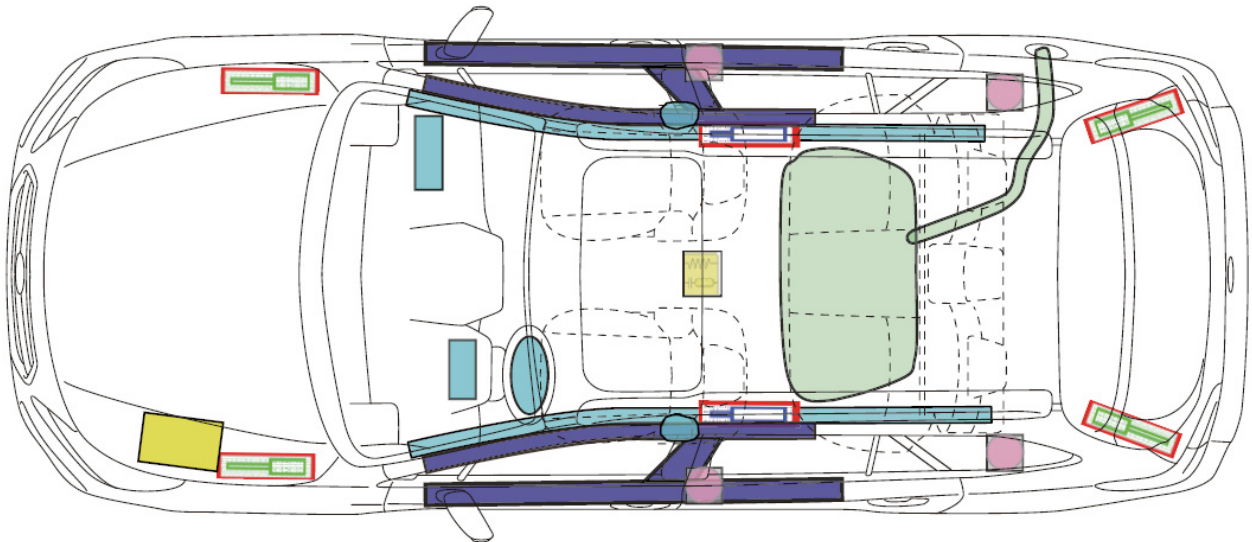

Airbag Modul		Karosserieverstärkungen		Airbag Kontrollmodul	
Fensterairbag Gasgenerator				Batterie	
Gurtstraffer		Hauben & Heckklappendämpfer		Kraftstofftank	

Warnhinweise

Nach dem Abklemmen der Batterie 30 Sekunden warten.

SUBARU: Outback Benzin & Diesel
 Typ: BSD/BS9
 Karosserievariante ab MJ 2015









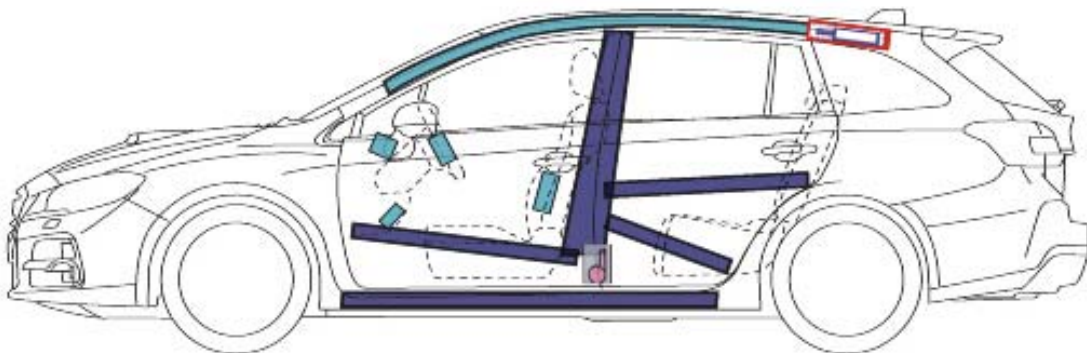
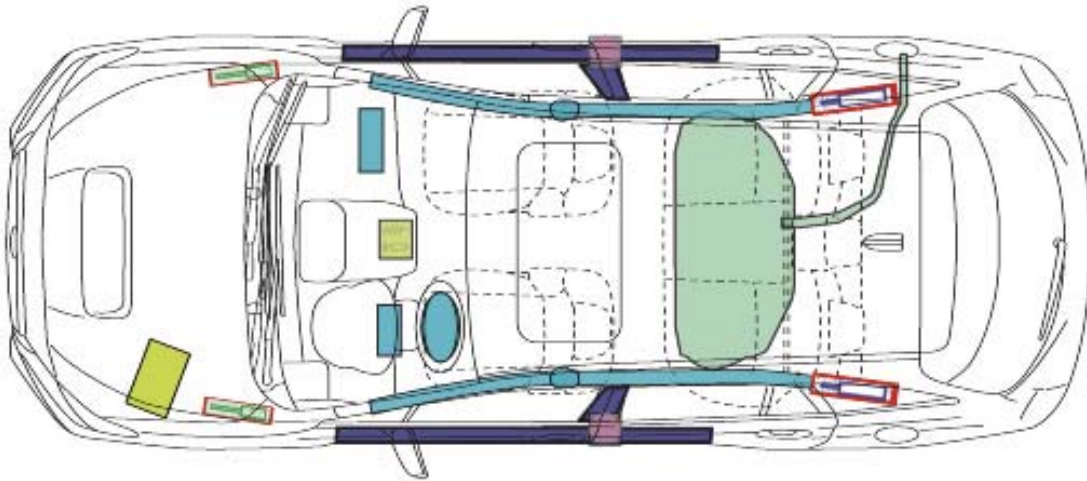

Airbag Modul		Karosserieverstärkung		Airbag Kontrollmodul	
Fensterairbag Gasgenerator				Batterie	
Gurtstraffer		Hauben & Heckklappendämpfer		Kraftstofftank	

Warnhinweise

Nach dem Abklemmen der Batterie 30 Sekunden warten.

SUBARU: Levorg
 Typ: VM
 Karosserievariante ab MJ 2016









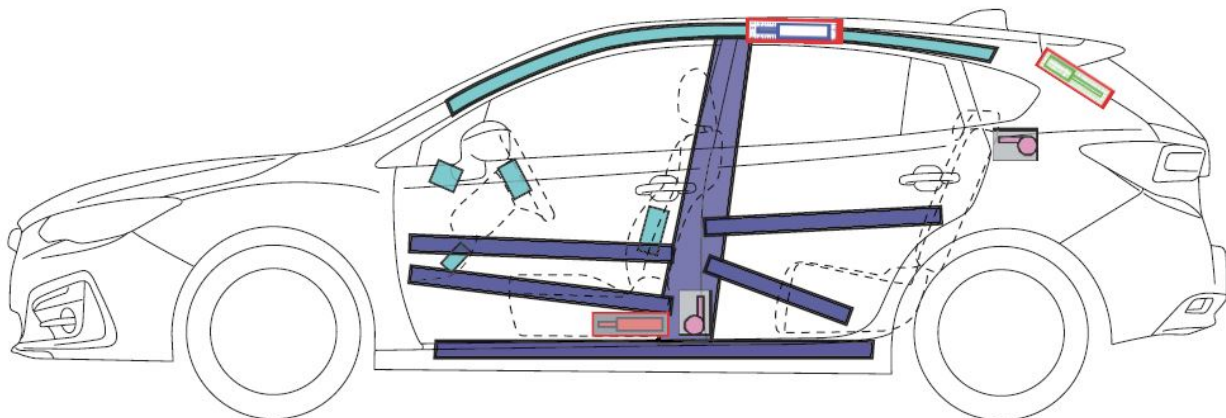
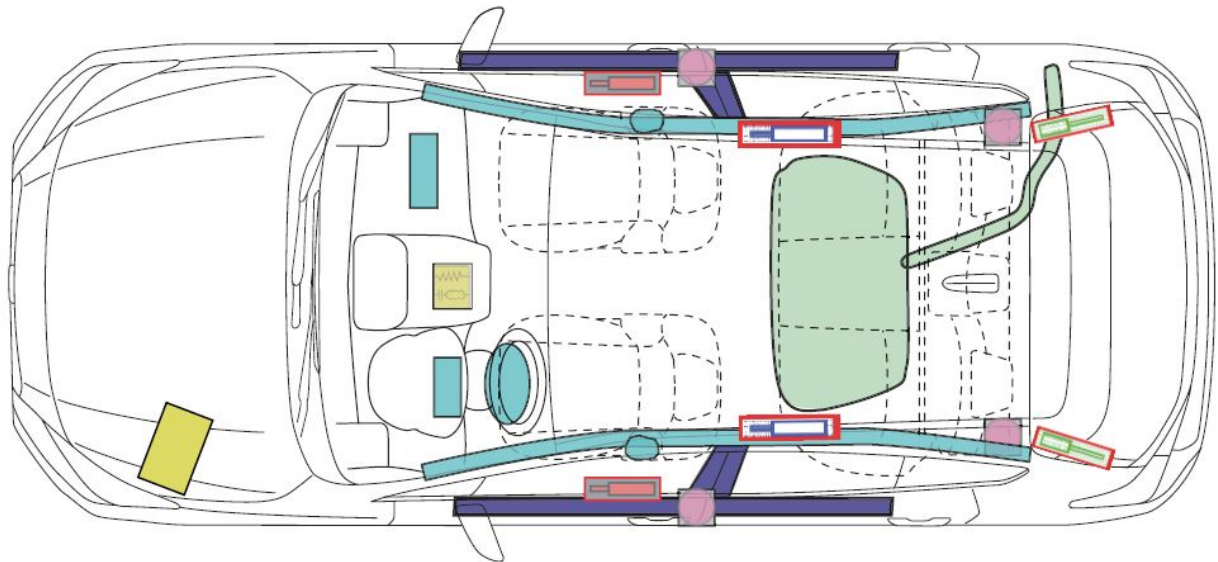

Airbag Modul		Karosserieverstärkung		Airbag Kontrollmodul	
Fensterairbag Gasgenerator				Batterie	
Gurtstraffer		Hauben & Heckklappendämpfer		Kraftstofftank	

Warnhinweise

Nach dem Abklemmen der Batterie 30 Sekunden warten.

SUBARU: Impreza / XV
 Typ: G5
 Karosserieversion ab MJ 2018



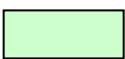







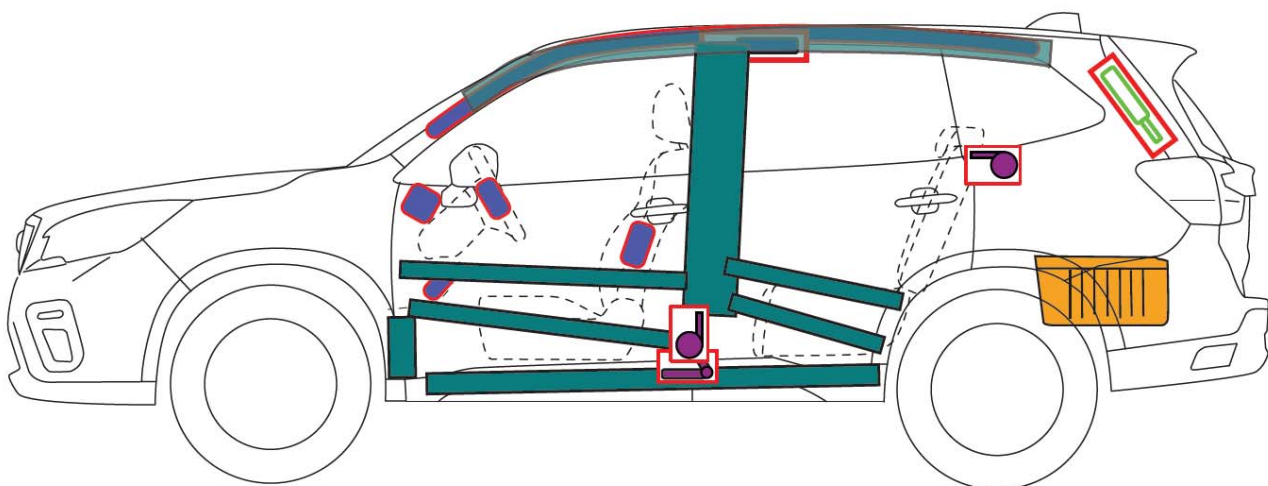
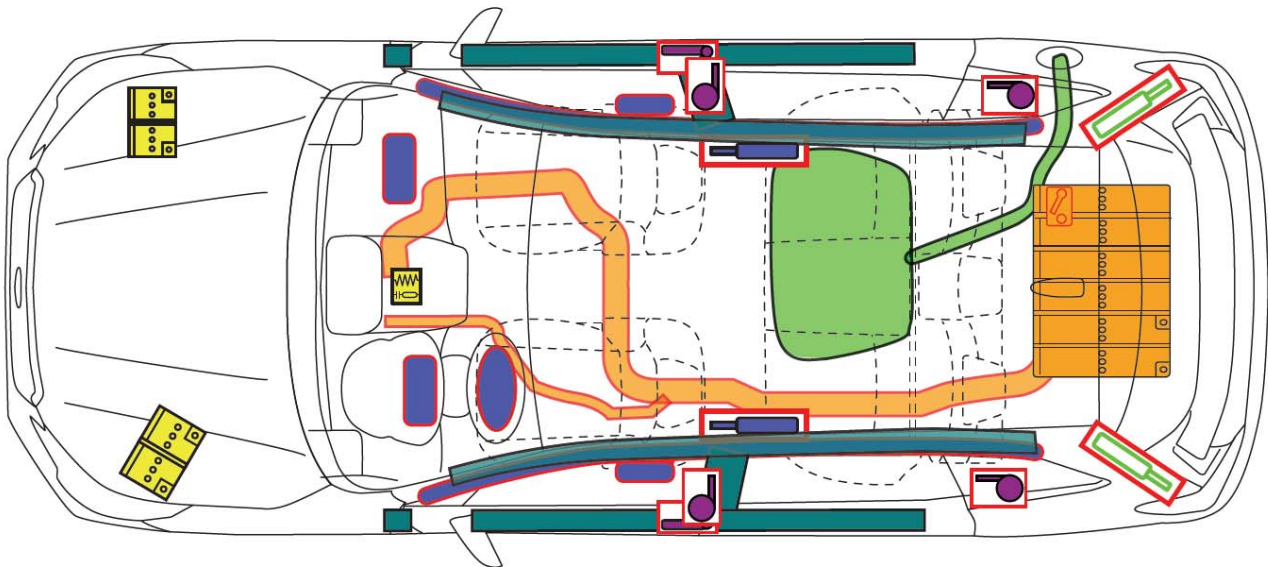

Airbag Modul		Karosserieverstärkungen		Airbag Kontrollmodul	
Fensterairbag Gasgenerator				Batterie	
Gurtstraffer		Hauben & Heckklappendämpfer		Kraftstofftank	

Warnhinweise

Nach dem Abklemmen der Batterie 30 Sekunden warten.

SUBARU: Forester
 Typ: S5
 Karosserievariante ab MJ 2020











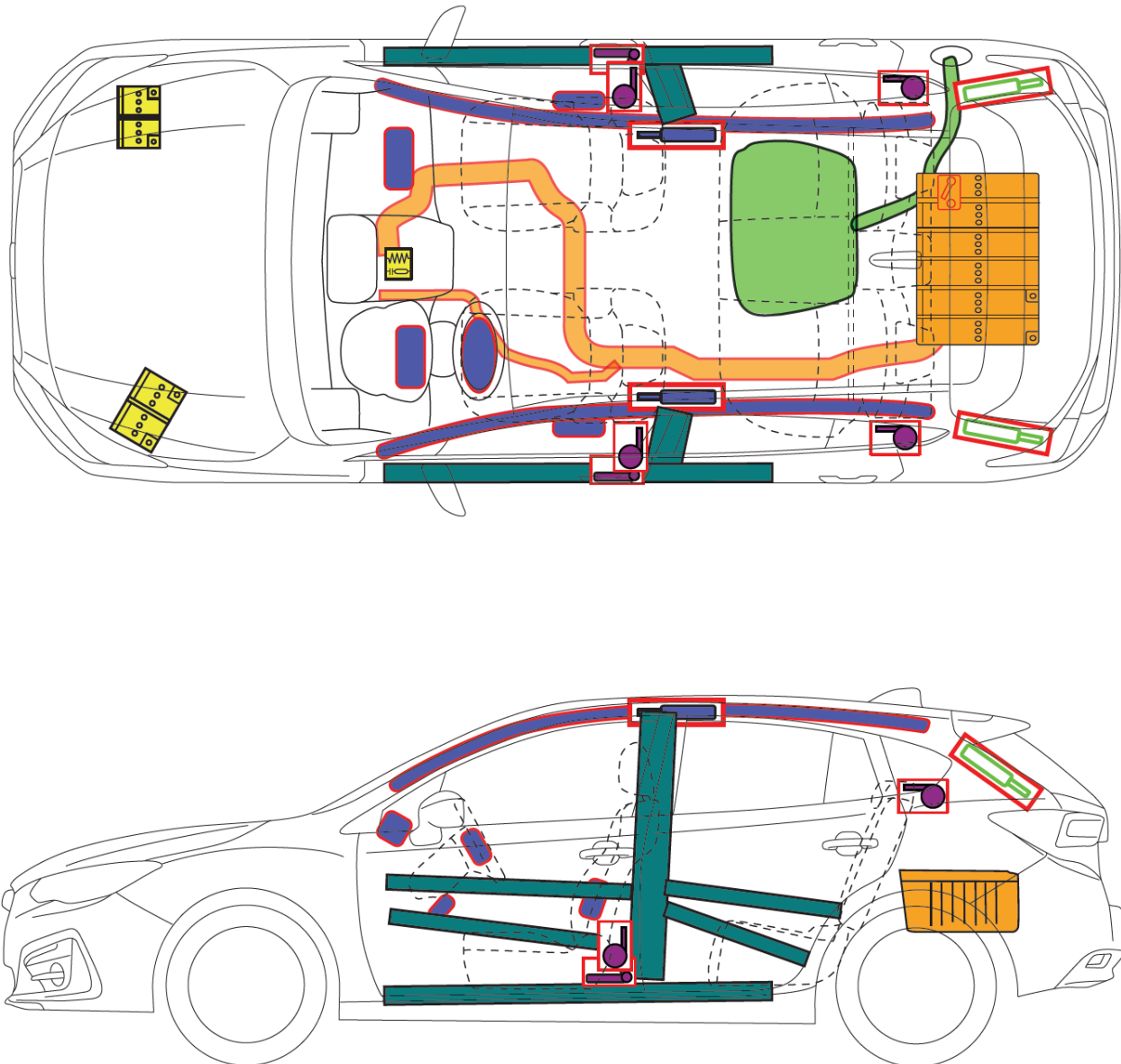

Airbag Modul		Karosserieverstärkung		Airbag Kontrollmodul	
Fensterairbag Gasgenerator		Hybridsystem		Batterie	
Gurtstraffer		Hauben & Heckklappendämpfer		Kraftstofftank	

Warnhinweise

Nach dem Abklemmen der Batterie 30 Sekunden warten.

SUBARU: Impreza
 Typ: G5
 Karosserievariante ab MJ 2020











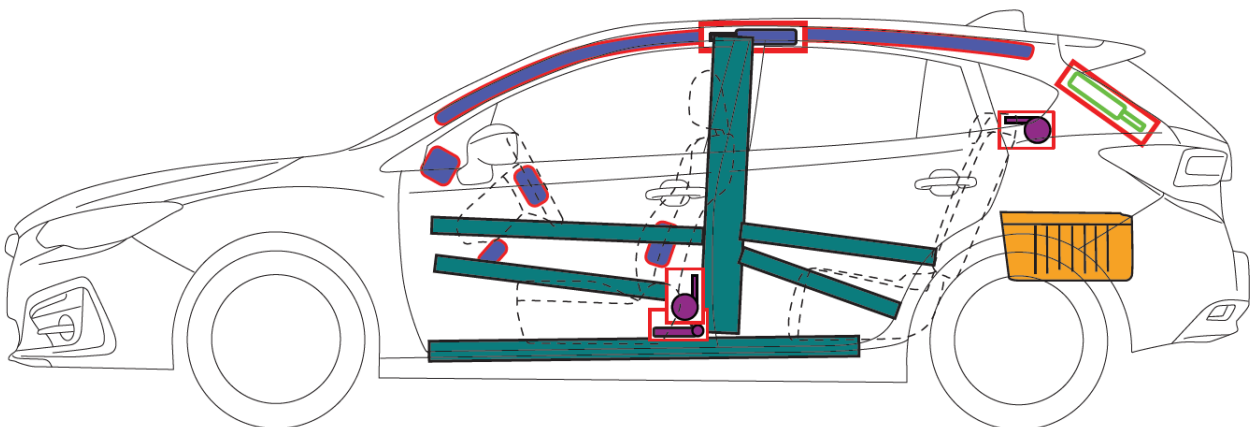
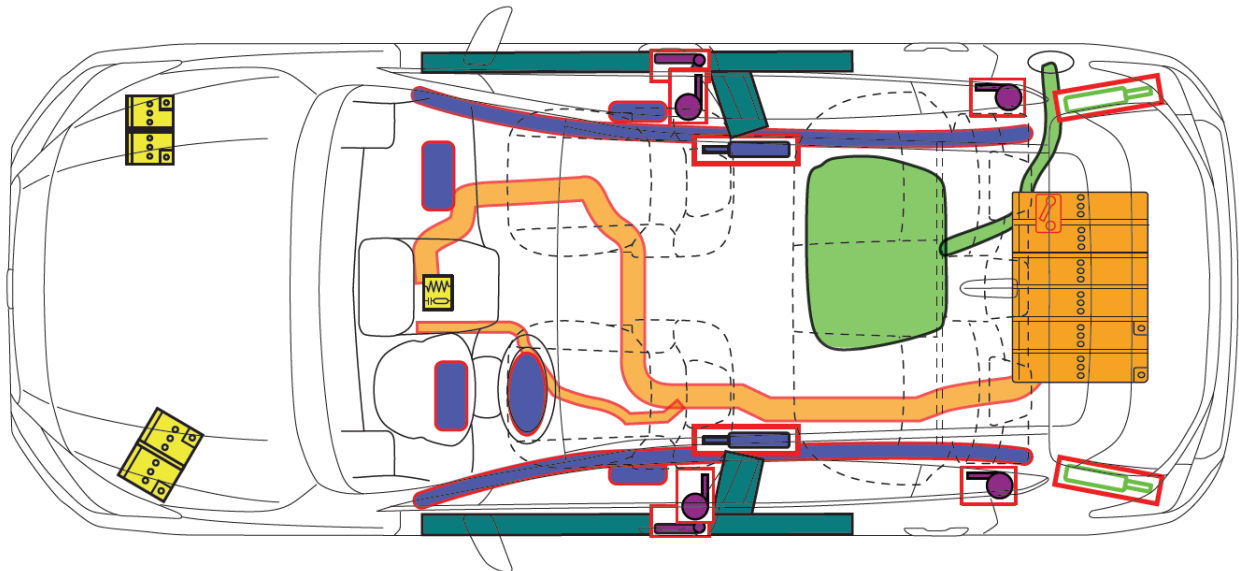

Airbag Modul		Karosserieverstärkung		Airbag Kontrollmodul	
Fensterairbag Gasgenerator		Hybridsystem		Batterie	
Gurtstraffer		Hauben & Heckklappendämpfer		Kraftstofftank	

Warnhinweise

Nach dem Abklemmen der Batterie 30 Sekunden warten.

SUBARU: SUBARU XV
 Typ: G5
 Karosserievariante ab MJ 2020



Airbag Modul		Karosserieverstärkung		Airbag Kontrollmodul	
Fensterairbag Gasgenerator		Hybridsystem		Batterie	
Gurtstraffer		Hauben & Heckklappendämpfer		Kraftstofftank	

Warnhinweise

Nach dem Abklemmen der Batterie 30 Sekunden warten.

SUBARU: Outback
 Typ: B7/BT9
 Karosserievariante ab MJ 2021

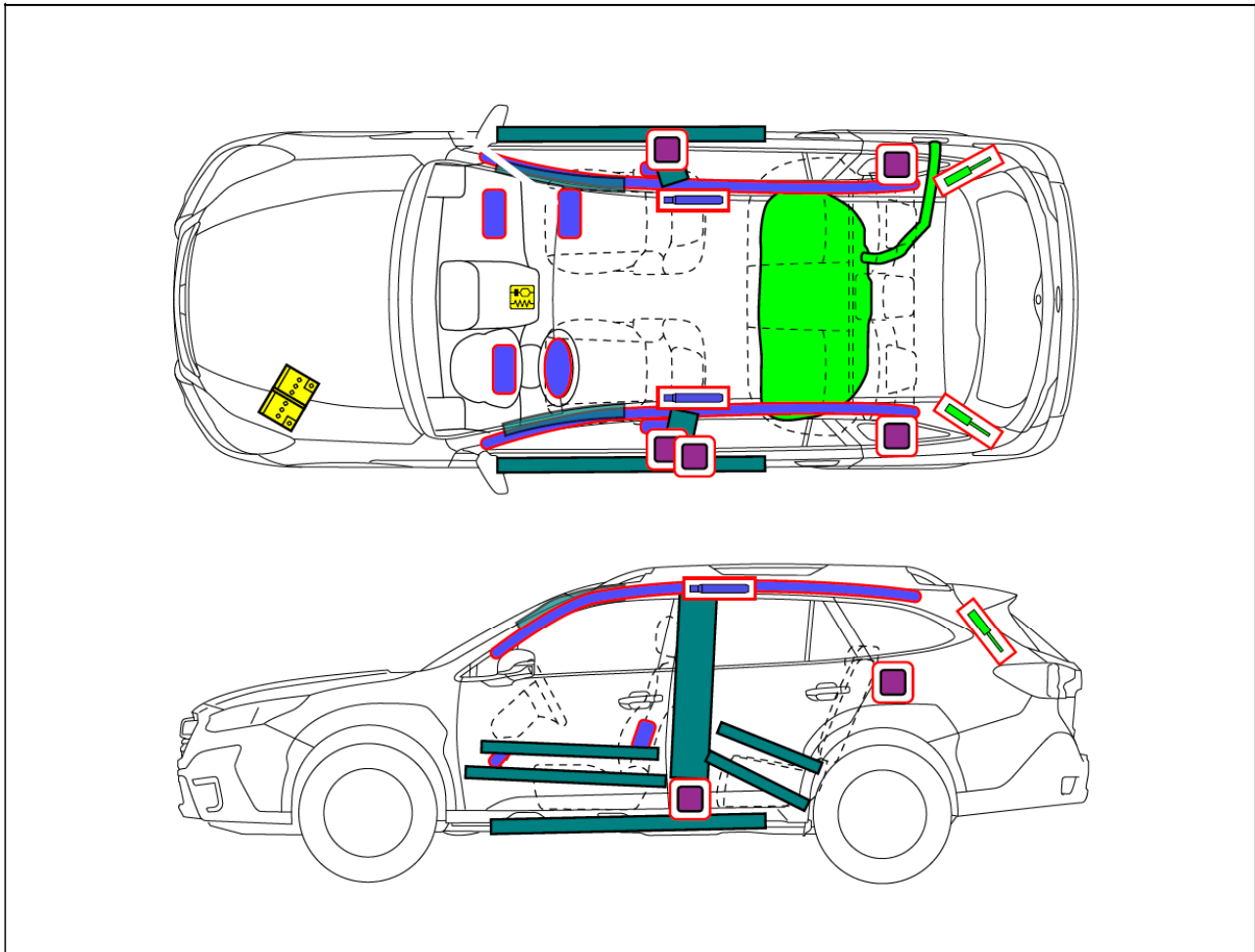

	Airbag		Gasgenerator		Gurtstraffer		SRS Steuergerät		Aktives Fußgänger-schutzsystem
	Automatisches Überroll-Schutzsystem		Gasdruckdämpfer / vorgespannte Feder		Karosserie-Verstärkung		Sensibler Bereich		
	Niedervolt-Batterie		Niedervolt-Kondensator		Treibstofftank		Gastank		Sicherheitsventil

Warnhinweise

Nach dem Abklemmen der Batterie 30 Sekunden warten.



SUBARU SOLTERRA
 Typ: EAM1S(M)
 Karosserievariante ab MJ 2023



RETTUNGSKARTE

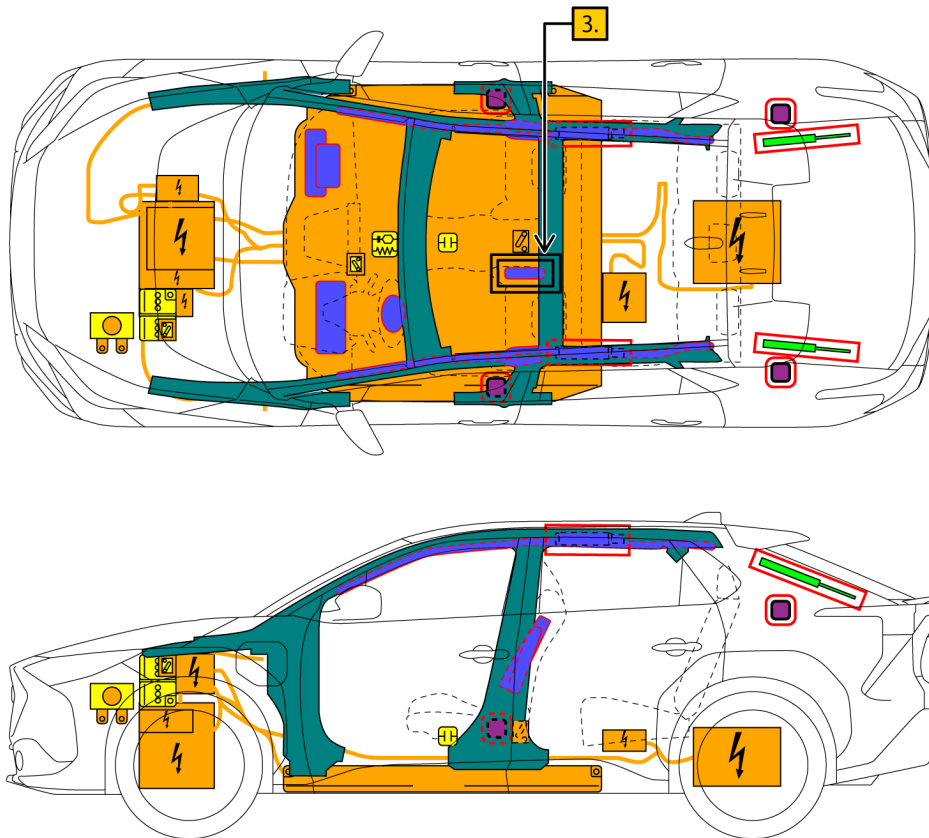

	Airbag		Gasdruck Patrone Airbag		Gurtstraffer		Airbag Steuergerät		Fußgänger- Schutzsystem
	Automatisches Überschlag- schutz System		Gasdruckdämpfer		Hochfeste Stahlteile		Zone requiring special attention		
	Batterie 12V		Niedrigvolt Kondensator		Kraftstofftank		Gastank		Sicherheitsventil
	Hochvoltbatterie		Hochvolt Kabelverbindung		Hochvolt- abschaltung		Sicherung zur Abschaltung Hochvoltsystems		Hochvolt- Kondensator
	Niederspannungs- einheit zur Abschaltung von Hochvolt								
	ID No.	Version No.		Version date		Page			
	SOLTERRA15	01		03 / 2022		1 / 4			

1. Identifikation

■ Positionen der Labels

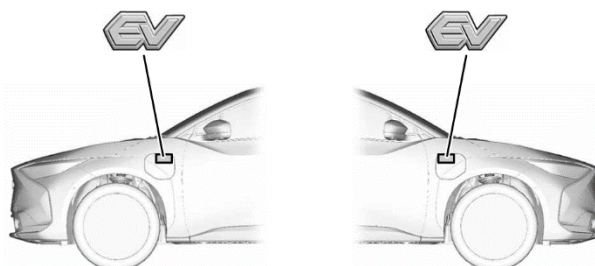
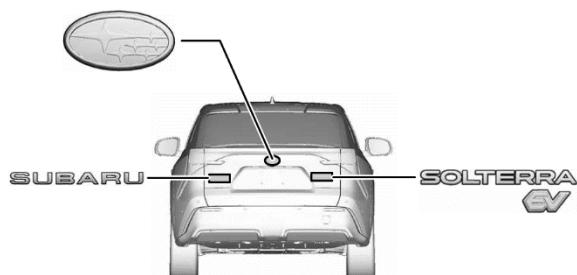

■ Energiequelle: Lithium-ionen Batterie



2. Immobilisierung / Stabilisierung / Anheben

■ Vollständiges Abschalten des Fahrzeugs

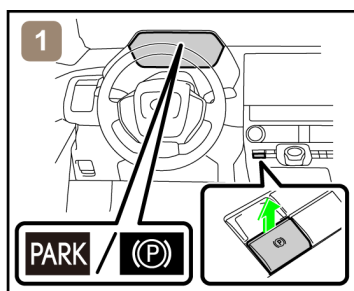

1) Vollständig Anhalten und Parkbremse aktivieren

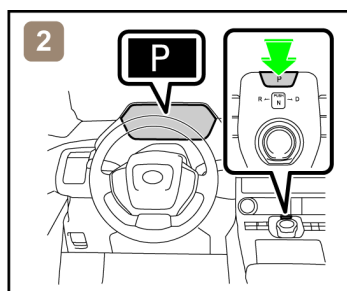

2) Position "P" wählen.

■ Stabilisierung-Anhebepunkte

Mit einer 4 Punkt Hebebühne an den markierten Punkten anheben. Vorsicht auf beschädigungsfreie Batterieachten

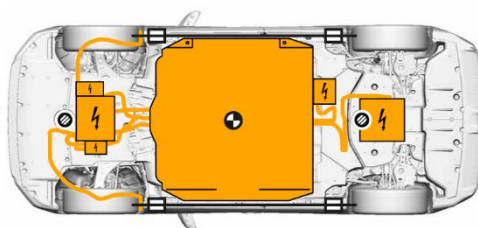

Versäkte Anhebepunkte



Standard-Hebebühne



Fahrzeugmittelpunkt



Legen Sie keine Untergestelle wie Holzklötze oder Lufthebekissen unter die Hochspannungskabel. Dies kann zu einem Brand oder Stromschlag führen.

ID No.	Version No.	Version date	Page
SOLTERRA15	01	03 / 2022	2 / 4

3. Gefahrenvermeidung / Sicherheitshinweise

- Wenn eines der folgenden Systeme betrieben werden muss, nutzen Sie es, **BEVOR** Sie die Batterie abklemmen.

Zentralverriegelung
Heckklappe

Fensterheber
Elektrische Parkbremse

Elektrische Sitzverstellung
Elektronischer Wählhebel



Bei abgeklemmter 12-V-Batterie können elektrische Komponenten nicht betrieben werden.

- angegebenes Verfahren oder Alternative durchführen, um das Fahrzeug vollständig abzuschalten.

<Vorgehensweise>

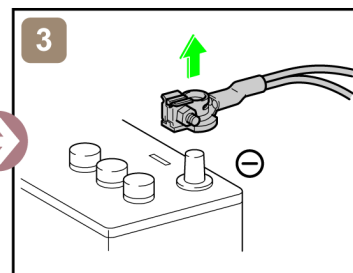
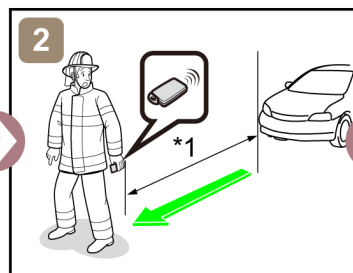
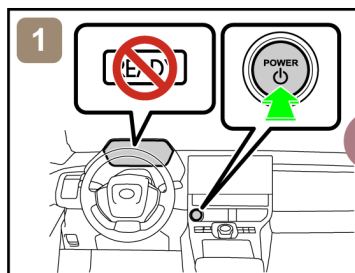
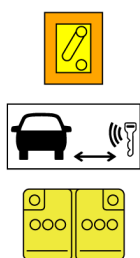

*1: 5 m oder mehr

Alternativethode>

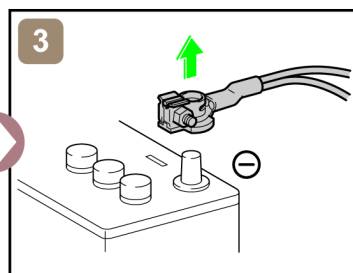
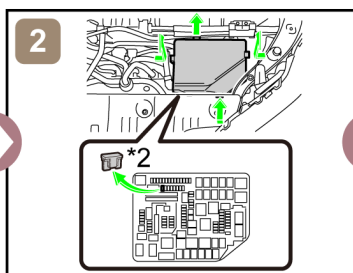
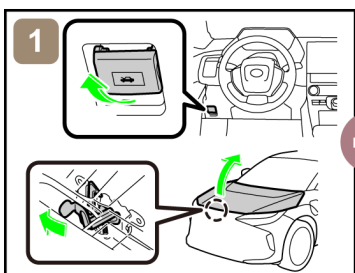
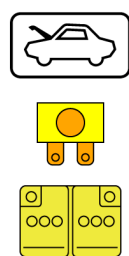

*2: Hauptsicherungskasten (30 A GREEN)

- Zugang zur 12 V Batterie

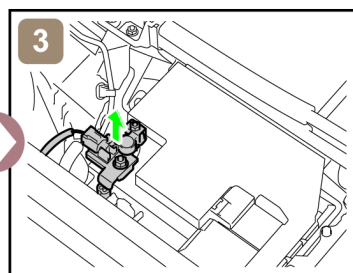
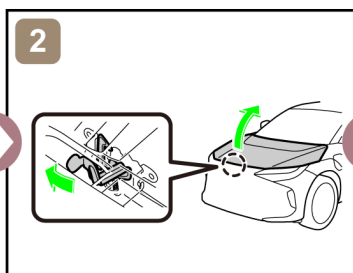
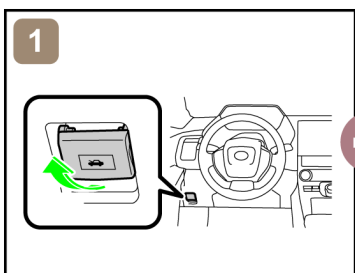
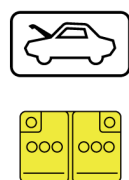

4. Zugang zu den Insassen

- Glasflächen

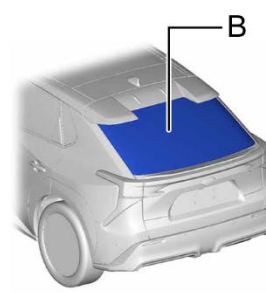
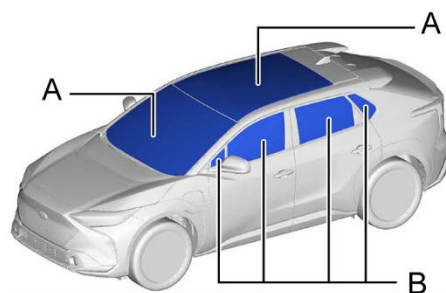

A	Zwei-Schicht Verglasung	B	Sicherheitsglas
---	-------------------------	---	-----------------

5. Energiesystem / Flüssigkeiten / Gase / Feststoffe



Hochvolt Li-Ionen Batterie



12 V Batterie



- Tragen Sie beim Umgang mit diesen Gegenständen immer geeignete persönliche Schutzausrüstung
- Unter keinen Umständen, einschließlich Feuer, die Abdeckung der Batteriebaugruppe beschädigen oder entfernen. Dies kann zu schweren Verletzungen oder zum Tod durch schwere Verbrennungen oder Stromschläge führen.

6. Im Falle eines Feuers



VERWENDEN SIE VIEL WASSER

Wenn es schwierig ist, reichlich Wasser auf die Hochspannungsbatterie aufzutragen, wird empfohlen, die Hochspannungsbatterie ausbrennen zu lassen.



WIEDERZÜNDUNG
MÖGLICH !



7. Im Falle von Untertauchen



Berühren Sie keine der Hochspannungskomponenten oder -kabel, einschließlich des Wartungssteckers, während das Fahrzeug unter Wasser ist. Dies kann zu einem Stromschlag führen. Arbeiten am Fahrzeug erst, nachdem das Fahrzeug aus dem Wasser gezogen wurde.

8. Abschleppen

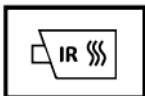
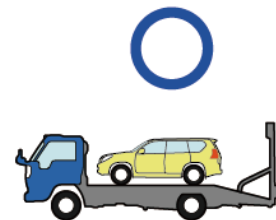

WIEDERZÜNDUNG
MÖGLICH !

Fahrzeug in sicherem Abstand (15 m oder mehr) zu anderen Fahrzeugen abstellen.

9. Wichtige zusätzliche Informationen







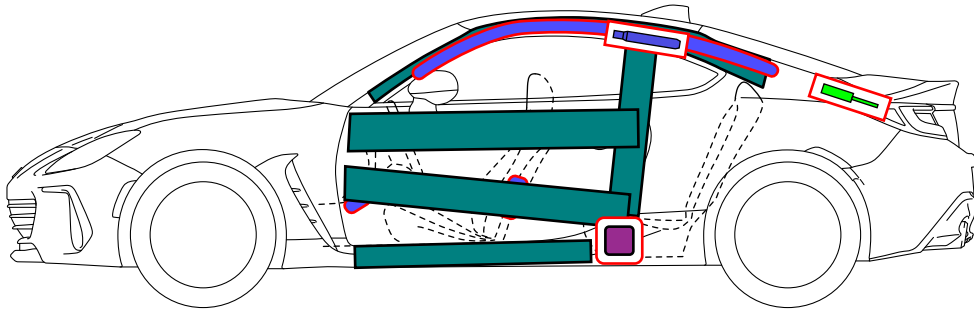
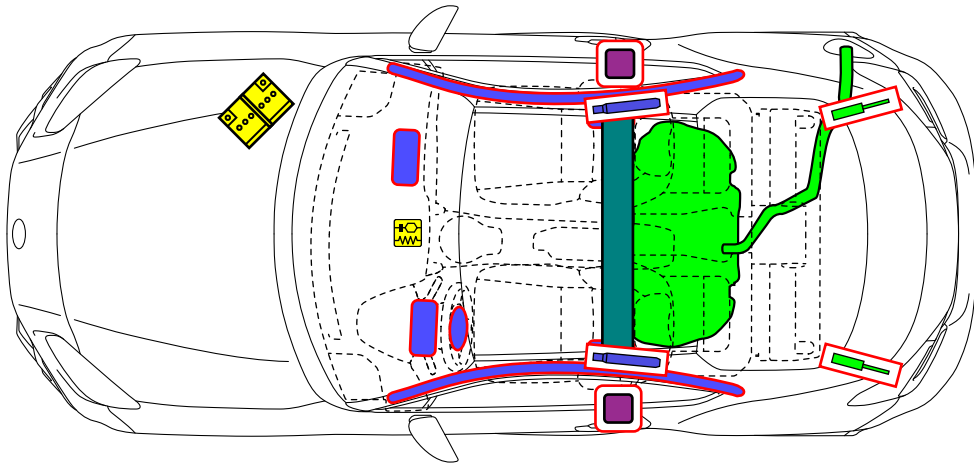
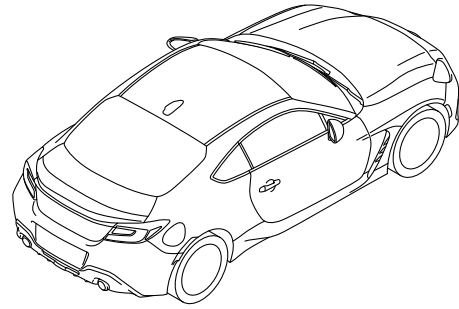
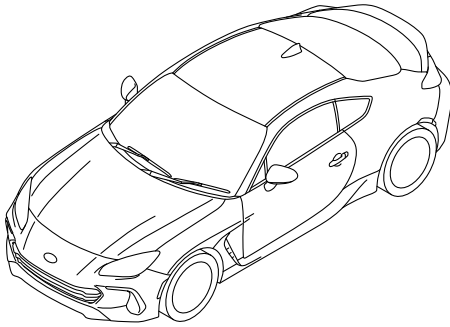

ID No.	Version No.	Version date	Page
SOLTERRA15	01	03 / 2022	4 / 4



SUBARU

SUBARU BRZ
Zweitüriges Coupé
2022-



	Airbag		Gasgenerator		Gurtstraffer		SRS Steuergerät		
	Gasdruckdämpfer / vorgespannte Feder		Karosserie-Verstärkung		Niedervolt-Batterie		Treibstofftank		

1. Identifizierung/Erkennung

Position der Fahrzeugemblem

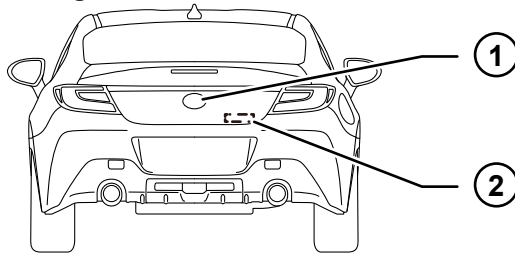

2. Immobilisieren/Stabilisieren/Anheben

Immobilisieren Sie das Fahrzeug vollständig

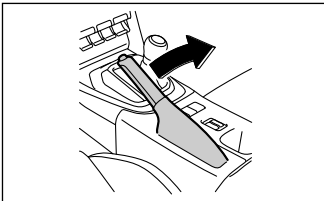

1. Zum Einstellen der Feststellbremse das Bremspedal fest drücken und gedrückt halten, bis der Feststellbremshebel vollständig hochgezogen ist.

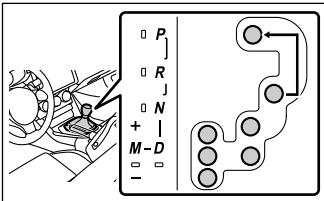

2. Den Wählhebel in Parkposition bringen. (Modell mit Automatikgetriebe)

Stabilisierung-Hebepunkt

An 4 Stellen direkt unter den Front- und Seitenschwellern stützen.

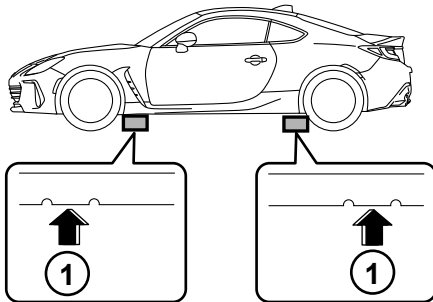

1 Stützstellen

3. Direkte Gefahren ausschalten/Sicherheitsbestimmungen

Wenn eines der folgenden Systeme bedient werden muss, tun Sie dies erst, BEVOR Sie die Batterie abklemmen.

Zentralverriegelung

Elektrischer Fensterheber



Sobald die 12-Volt-Hilfsbatterie getrennt ist, funktionieren die elektrischen Verstellungen nicht mehr.

Führen Sie das Haupt- oder Alternativverfahren durch, um das Fahrzeug vollständig abzuschalten.

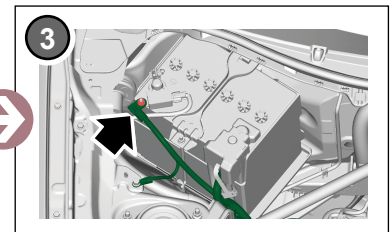
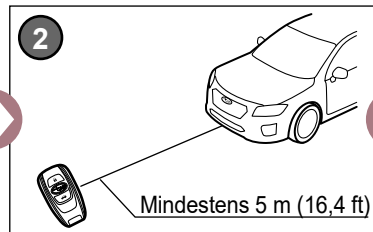
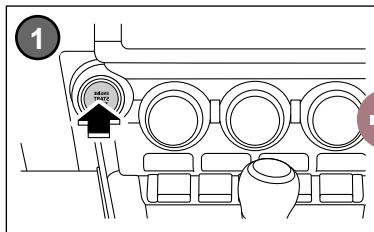
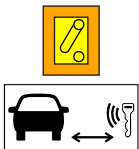

Zugriff auf Niedervolt-Batterie

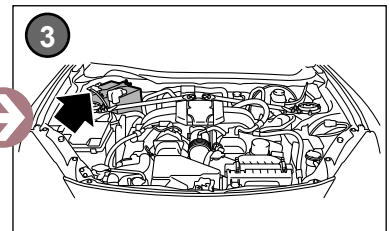
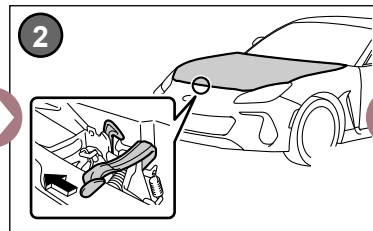
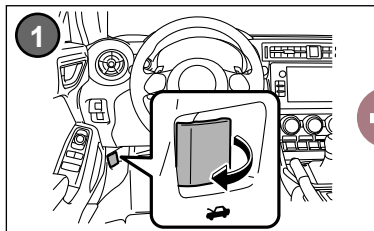
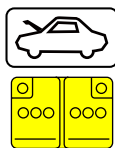

4. Zugang zu den Insassen

■ Fensterscheiben

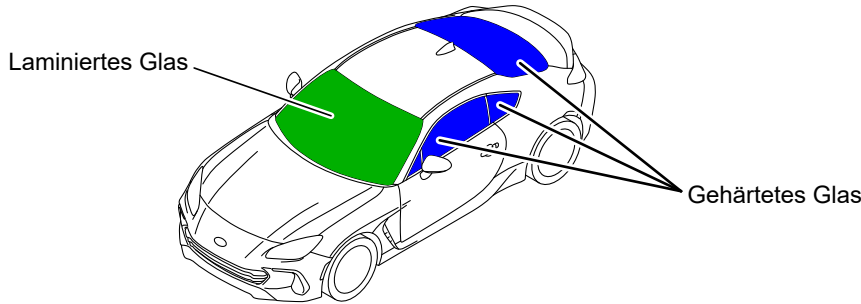

■ Sitzverstellung

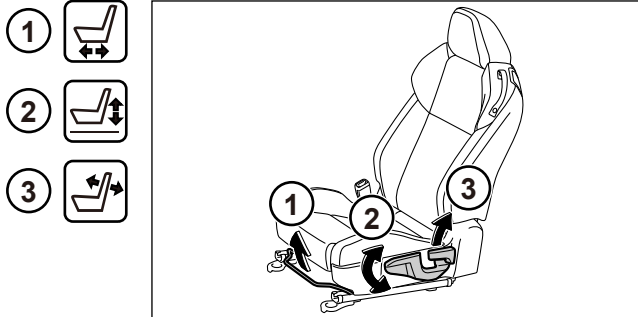

■ Einstellung der Lenksäule

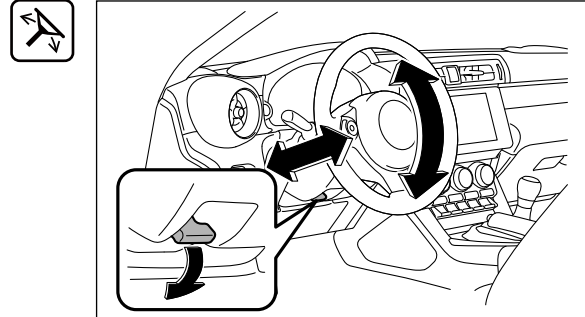

■ Hochfestigkeitsstahl in Karosserie

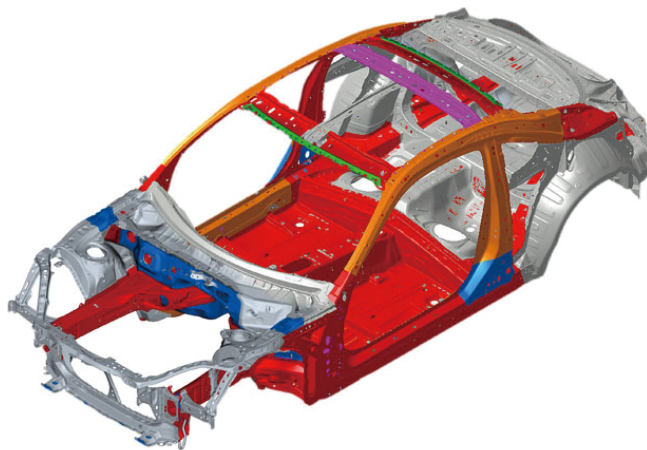





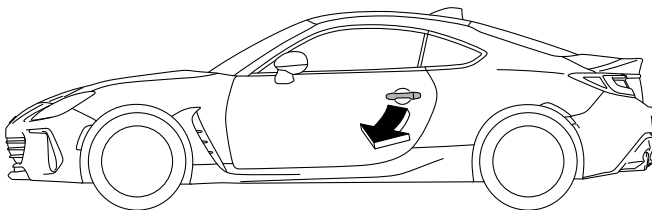

- Aluminiummaterial
- 270 MPa (2.753 kgf /cm², 39.150 psi)
- 400 bis 440 MPa (4.079 bis 4.487 kgf /cm², 57.999 bis 63.799 psi)
- 590 MPa (6.016 kgf /cm², 85.549 psi)
- 980 MPa (9.993 kgf /cm², 140.299 psi)
- 1.500 MPa (15.295 kgf /cm², 217.498 psi)

■ Türschlösser



5. Gespeicherte Energie/Flüssigkeiten/Gase/Feststoffe

	12 V	
	50 L	
	HFC-134a : 0,39 kg (0,86 lb) HFO-1234yf : 0,40 kg (0,88 lb)	

6. Im Brandfall



7. Im Falle des Untertauchens

Holen Sie das Fahrzeug wenn möglich aus dem Wasser und fahren Sie mit dem Deaktivierungsverfahren für dieses Fahrzeug fort (siehe Kapitel 3).

8. Abschleppen/Transport/Lagerung

O = OK

⊘ = NG

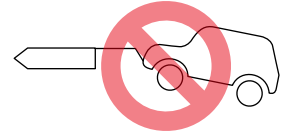
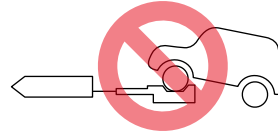
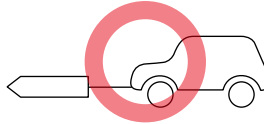
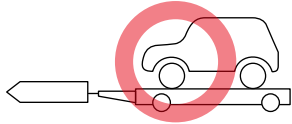

Weniger als 30 km/h (19 MPH)

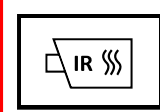

**WIEDERENTZÜNDUNG
MÖGLICH!**

Stellen Sie das Fahrzeug mit ausreichend Sicherheitsabstand zu anderen Fahrzeugen ab.

Position des vorderen Hakens



Position des hinteren Hakens

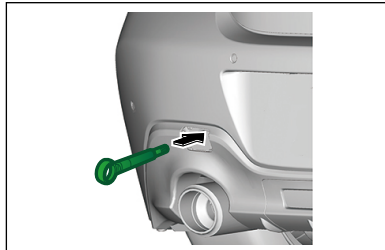

Position der Werkzeuge (Typ A)

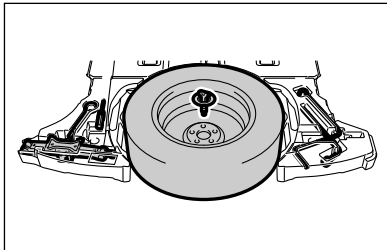

Position der Werkzeuge (Typ B)

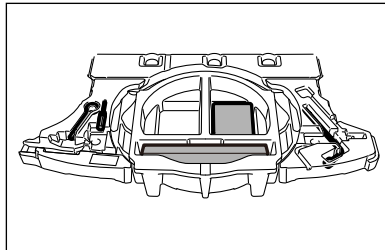

9. Wichtige zusätzliche Informationen

10. Erläuterung der verwendeten Piktogramme

	Fahrzeug mit flüssigen Kraftstoffen der Kl. 2		Niedervolt-Batterie		Treibstofftank
	Regelung der Lenkradneigung		Sitzhöhenverstellung		Motorhaube
	Sitzlehnenverstellung		Horizontale Sitzverstellung		IR-Wärmebildkamera benutzen
	Smart-Schlüssel entfernen		Klimaanlage		Gefahr
	Gas unter Druck		Explosiv		Entzündbar
	Korrosiv		Gesundheitsschädlich		

ID Nr.

JF1-T4600GG

Versions-Nr.

01

Versions-Datum

07/2022

Seite

4 / 4



SUBARU

SUBARU Impreza HYBRID
SUBARU Crosstrek HYBRID
Fünftüriger Wagen
2023-



Typ G6

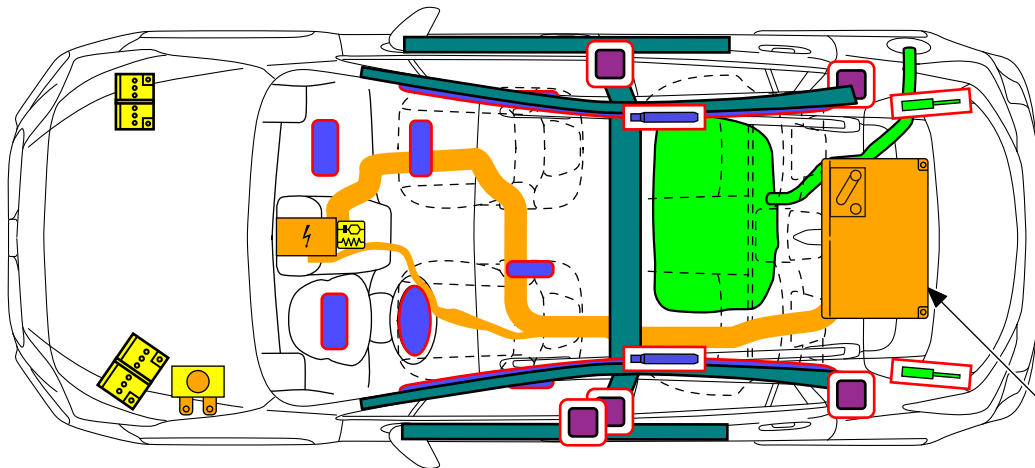
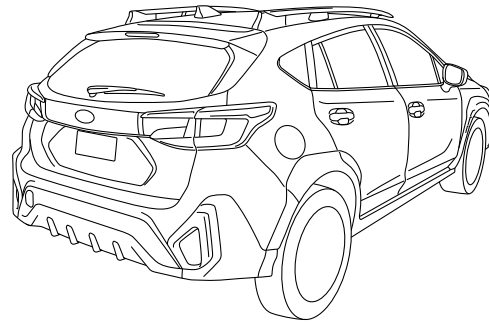
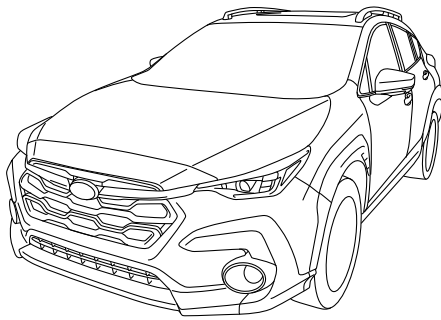

118,4 V
Lithium-Ionen

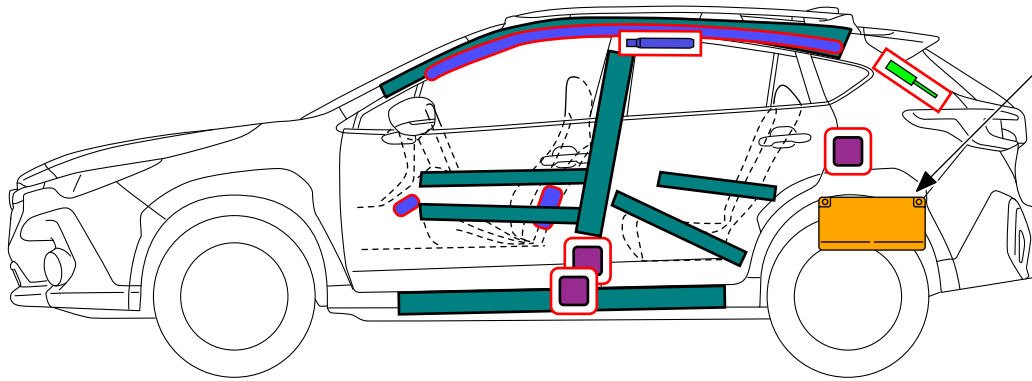

	Airbag		Gasgenerator		Gurtstraffer		SRS Steuergerät		
	Niedervolt-Batterie		Gasdruckdämpfer / vorgespannte Feder		Treibstofftank		Karosserie-Verstärkung		Sensibler Bereich
	Hochspannungs-batterie		Hochspannungs-kabel		Hochspannungs-element das die Hochspannung abschaltet		Sicherungen / Abschalten der Hochspannung		
	Hochspannungs-komponente								
	ID Nr.	Versions-Nr.		Versions-Datum		Seite			
	JF1-T1540DE	04		11/2024		1 / 4			

1. Identifizierung/Erkennung

Position der Fahrzeugembleme

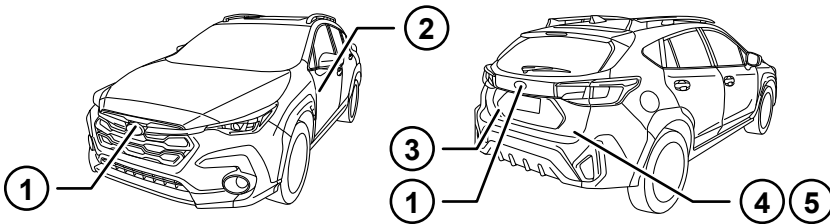

1		4	CROSSTREK e-BOXER
2	e-BOXER	5	IMPREZA e-BOXER
3	SUBARU AWD		



Nehmen Sie nie an, dass der e-BOXER ausgeschaltet ist, nur weil er lautlos ist.

2. Immobilisieren/Stabilisieren/Anheben

Immobilisieren Sie das Fahrzeug vollständig

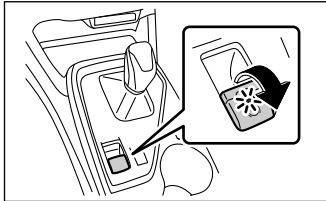

1. Blockieren Sie die Räder und ziehen Sie die Feststellbremse an.

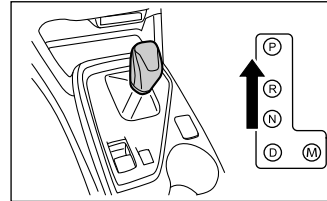

2. Bringen Sie den Schalthebel in die Stellung P (Parken).

Stabilisierung-Hebepunkt

An 4 Stellen direkt unter den Front- und Seitenschwellern stützen.

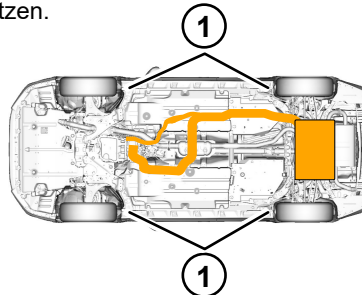
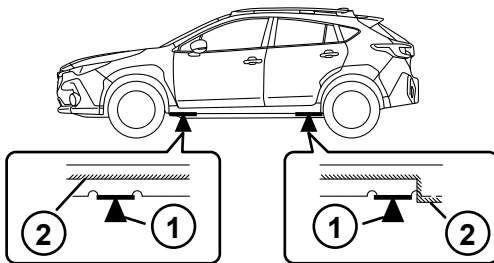

- 1 Stützstellen
- 2 Seitenschwellerzierleiste
- Hochspannung



Platzieren Sie keine Stützen unter den orangefarbenen Stromkabeln, dem Abgassystem oder dem Kraftstoffsystem.

3. Direkte Gefahren ausschalten/Sicherheitsbestimmungen

Wenn eines der folgenden Systeme bedient werden muss, tun Sie dies erst, BEVOR Sie die Batterie abklemmen.

Zentralverriegelung

Elektrischer Fensterheber

Heckklappenöffner

Elektrische Feststellbremse

Elektrische Sitzverstellungen



Sobald die 12-Volt-Hilfsbatterie getrennt ist, funktionieren die elektrischen Verstellungen nicht mehr.

1. Verfahren zum Abschalten des Hochspannungs-Stromkreises und zum Abschalten des 12V-Stromkreises

<Zündschlüssel auf Stellung OFF drehen> : Hochspannungs-Stromkreis und 12V-Systemstromkreis ausgeschaltet lassen.



2A. Unterbrechung des Hochspannungs-Stromkreises

<Service-Stecker ausbauen>



- Falls der Hochspannungs-Stromkreis nicht abgeschaltet werden kann, nicht die Hochspannungskomponenten und die Hochspannungsbatterie berühren, trennen oder öffnen.
- Zur Vermeidung von Verletzungen persönliche Schutzausrüstung einschließlich unabhängigem Atemschutzgerät tragen, die für organische Lösungsmittel geeignet ist.

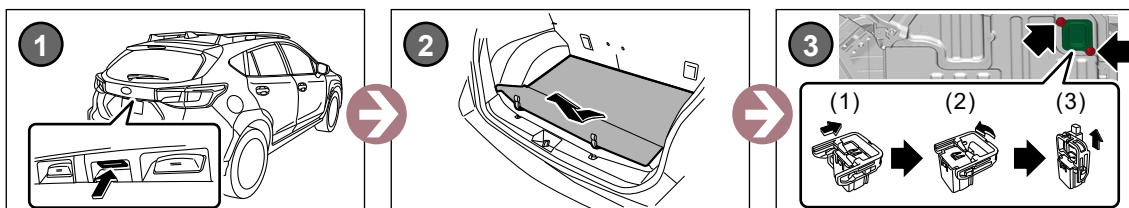

Im Falle einer Kollision mit Airbagauslösung und/oder Aktivierung der Gurtstraffer wird das Antriebssystem deaktiviert. Die Rückhaltesysteme sind noch aktiv.

ID Nr.	Versions-Nr.	Versions-Datum	Seite
JF1-T1540DE	04	11/2024	2 / 4

2B. <Alternative> Unterbrechung des 12V-Stromkreises



Falls die Masseklemme der 12V-Batterie nicht entfernt werden kann, kann der 12V-Stromkreis nicht abgeschaltet werden. Seien Sie beim Arbeiten vorsichtig, da sich das SRS-Airbag-System durch einen Kurzschluss oder einen Stoß auf den Kabelstrang plötzlich ausdehnen kann, was zu schweren Verletzungen führen kann.

<Die Masseklemme vom Batteriesensor trennen>

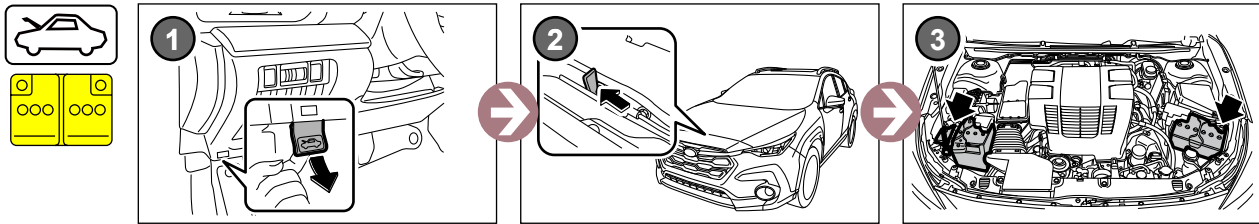

<Alternativ entfernen Sie die SICHERUNG>

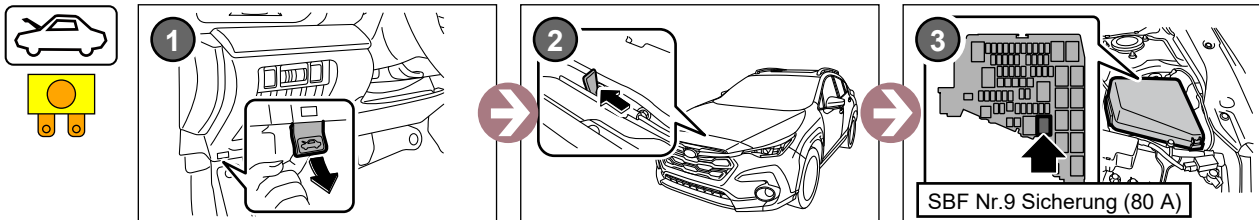

4. Zugang zu den Insassen

■ Fensterscheiben

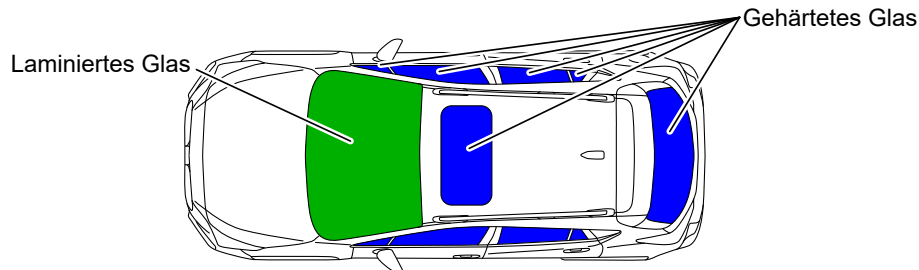

■ Sitzverstellung

<Elektrisch>

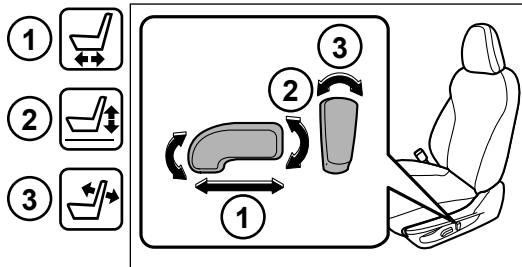

<Manuell>

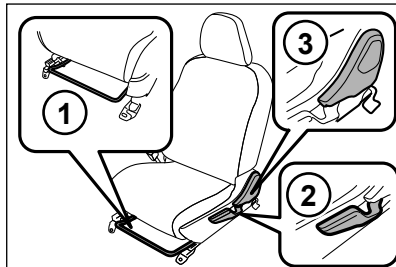

■ Einstellung der Lenksäule

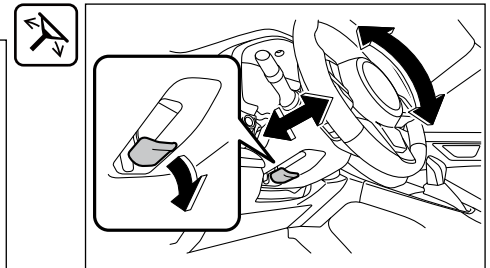

■ Hochfestigkeitsstahl in Karosserie

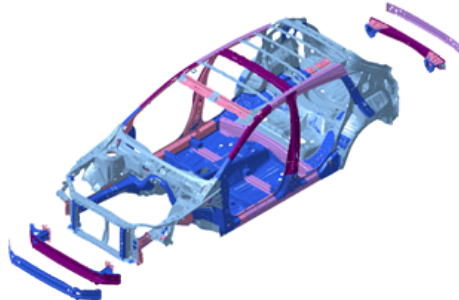

- 270 MPa (2.753 kgf /cm², 39.150 psi)
- 340 MPa (3.467 kgf /cm², 49.299 psi)
- 400 bis 500 MPa (4.079 bis 5.098 kgf /cm², 57.999 bis 72.499 psi)
- 590 MPa (6.016 kgf /cm², 85.549 psi)
- 980 MPa (9.993 kgf /cm², 140.299 psi)
- 1.180 MPa (12.032 kgf /cm², 171.098 psi)
- 1.500 MPa (15.295 kgf /cm², 217.498 psi)

■ Türschlösser

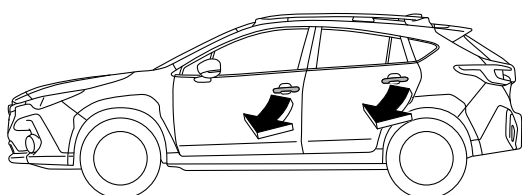



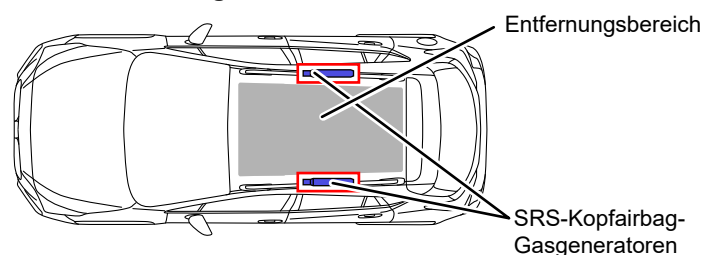













■ Dachentfernungsbereich







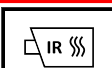

ID Nr.	Versions-Nr.	Versions-Datum	Seite
JF1-T1540DE	04	11/2024	3 / 4

5. Gespeicherte Energie/Flüssigkeiten/Gase/Feststoffe

	Lithium-Ionen: 118,4 V	    
	12 V	  
	48 L	
	HFC-134a : 0,475 kg (1,05 lb) HFO-1234yf : 0,475 kg (1,05 lb)	  



6. Im Brandfall

	REICHLICH WASSER VERWENDEN	Wenn es schwierig ist, reichlich Wasser auf die Hochspannungsbatterie anzuwenden, empfiehlt es sich, die Hochspannungsbatterie sich selbst ausbrennen zu lassen.
	WIEDERENTZÜNDUNG MÖGLICH!	     

7. Im Falle des Untertauchens

	Berühren Sie nicht den Service-Trennstecker, die Hochspannungsteile und die Verkabelung, um einen Stromschlag zu vermeiden, wenn das Fahrzeug eingetaucht ist. Bitte schalten Sie das Hybridsystem ab, nachdem Sie das Fahrzeug vollständig aus dem Wasser gezogen haben.
---	--

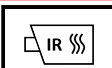
8. Abschleppen/Transport/Lagerung

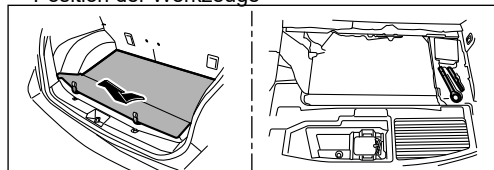





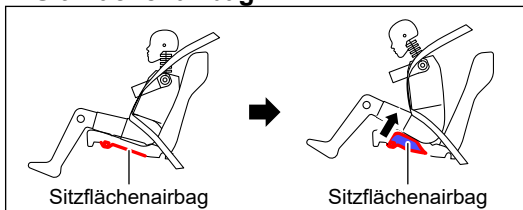

	Weniger als 30 km/h (19 MPH)	
	WIEDERENTZÜNDUNG MÖGLICH!	Stellen Sie das Fahrzeug mit ausreichend Sicherheitsabstand zu anderen Fahrzeugen ab.
Position des vorderen Hakens	Position des hinteren Hakens	Position der Werkzeuge
		

9. Wichtige zusätzliche Informationen

■ Sitzflächenairbag



10. Erläuterung der verwendeten Piktogramme

	Elektrohybridfahrzeug mit flüssigen Kraftstoffen der Kl. 2		Klimaanlage		Motorhaube
	Regelung der Lenkradneigung		Sitzhöhenverstellung		Sitzlehnenverstellung
	Horizontale Sitzverstellung		Gefahr		Spannungsgefahr
	Smart-Schlüssel entfernen		IR-Wärmebildkamera benutzen		Entzündbar
	Gas unter Druck		Explosiv		Akute Toxizität
	Korrosiv		Gesundheitsschädlich		Anschlagpunkt



SUBARU

SUBARU Forester HYBRID

Fünftüriger SUV
2025-



Typ S6

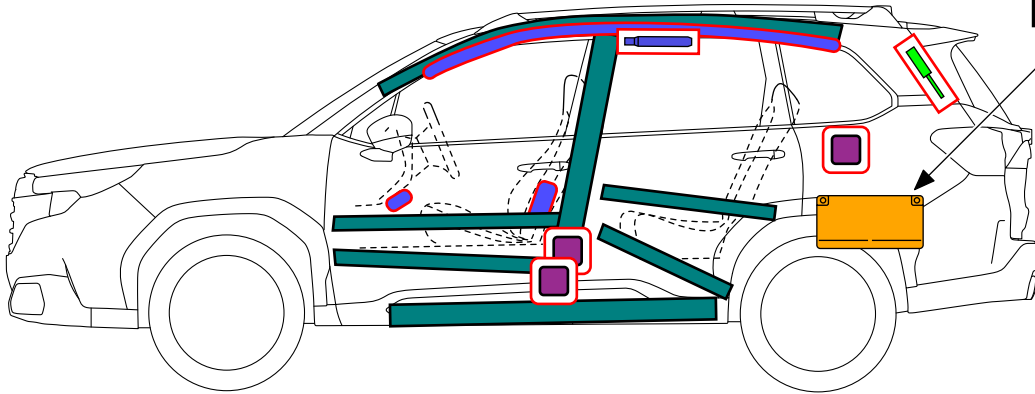
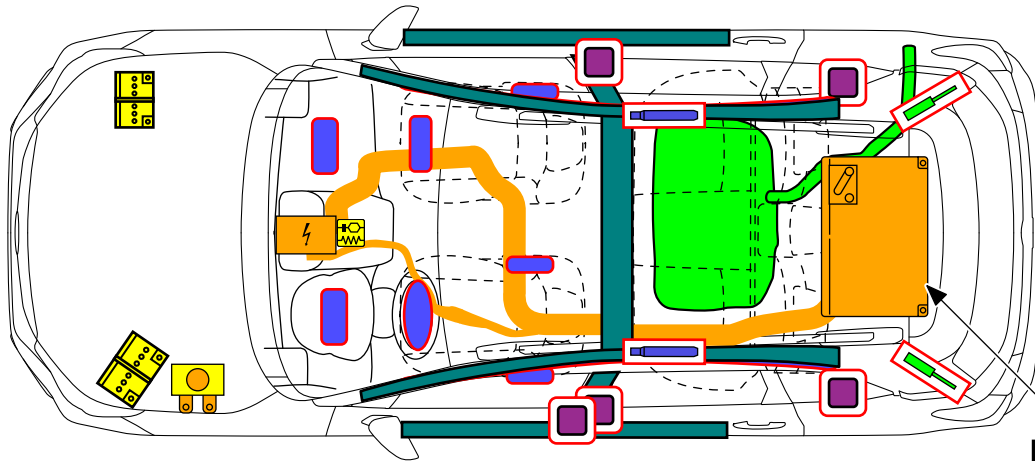
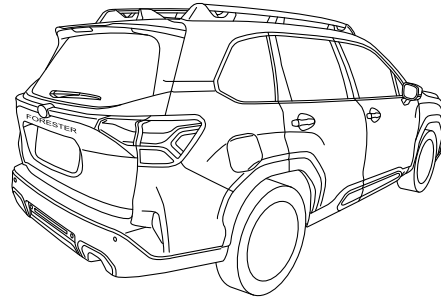
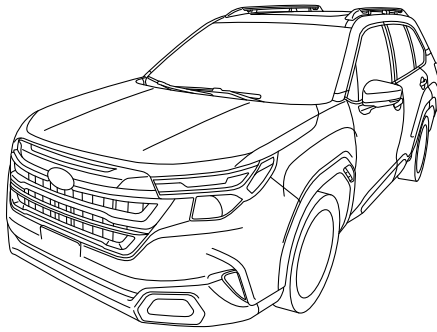

118,4 V
Lithium-Ionen

	Airbag		Gasgenerator		Gurtstraffer		SRS Steuergerät		
	Niedervolt-Batterie		Gasdruckdämpfer / vorgespannte Feder		Treibstofftank		Karosserie-Verstärkung		Sensibler Bereich
	Hochspannungs-batterie		Hochspannungs-kabel		Hochspannungs-element das die Hochspannung abschaltet		Sicherungen / Abschalten der Hochspannung		
	Hochspannungs-komponente								
		ID Nr.		Versions-Nr.		Versions-Datum		Seite	
		JF1-T8380DE		03		11/2024		1 / 4	

1. Identifizierung/Erkennung

Position der Fahrzeugembleme

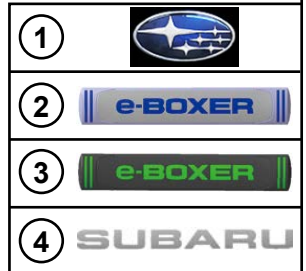
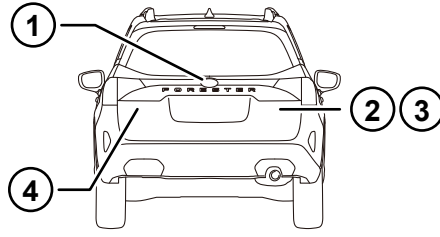
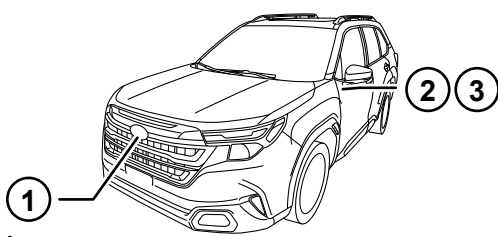

Nehmen Sie nie an, dass der e-BOXER ausgeschaltet ist, nur weil er lautlos ist.

2. Immobilisieren/Stabilisieren/Anheben

Immobilisieren Sie das Fahrzeug vollständig

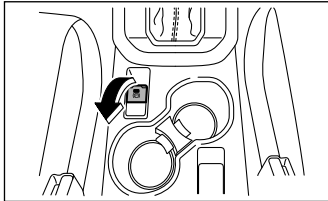

1. Blockieren Sie die Räder und ziehen Sie die Feststellbremse an.

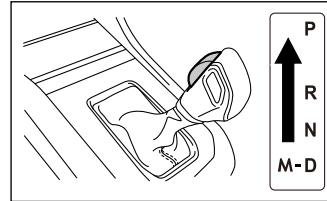

2. Bringen Sie den Schalthebel in die Stellung P (Parken).

Stabilisierung-Hebepunkt

An 4 Stellen direkt unter den Front- und Seitenschwellern stützen.

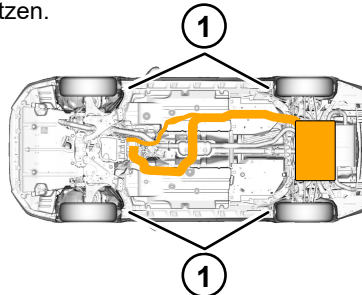
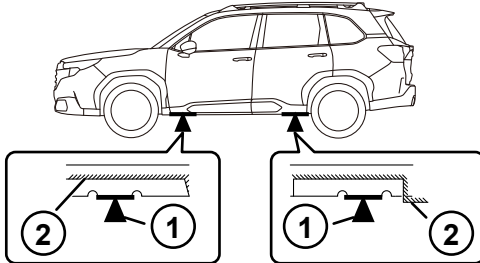

- 1 Stützstellen
- 2 Seitenschwellerzuerleiste
- Hochspannung



Platzieren Sie keine Stützen unter den orangefarbenen Stromkabeln, dem Abgassystem oder dem Kraftstoffsystem.

3. Direkte Gefahren ausschalten/Sicherheitsbestimmungen

Wenn eines der folgenden Systeme bedient werden muss, tun Sie dies erst, BEVOR Sie die Batterie abklemmen.

Zentralverriegelung

Elektrischer Fensterheber

Heckklappenöffner

Elektrische Feststellbremse

Elektrische Sitzverstellungen



Sobald die 12-Volt-Hilfsbatterie getrennt ist, funktionieren die elektrischen Verstellungen nicht mehr.

1. Verfahren zum Abschalten des Hochspannungs-Stromkreises und zum Abschalten des 12V-Stromkreises

<Zündschlüssel auf Stellung OFF drehen> : Hochspannungs-Stromkreis und 12V-Systemstromkreis ausgeschaltet lassen.

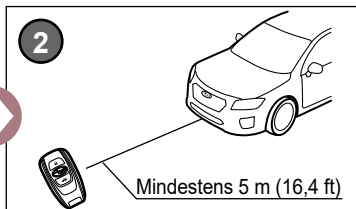
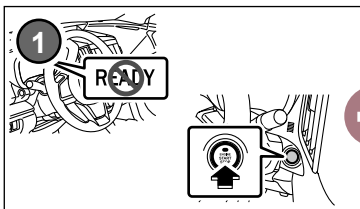

2A. Unterbrechung des Hochspannungs-Stromkreises

<Service-Stecker ausbauen>



- Falls der Hochspannungs-Stromkreis nicht abgeschaltet werden kann, nicht die Hochspannungskomponenten und die Hochspannungsbatterie berühren, trennen oder öffnen.
- Zur Vermeidung von Verletzungen persönliche Schutzausrüstung einschließlich unabhängigem Atemschutzgerät tragen, die für organische Lösungsmittel geeignet ist.

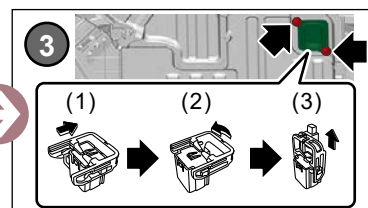
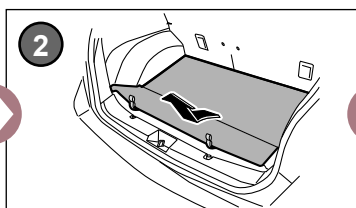
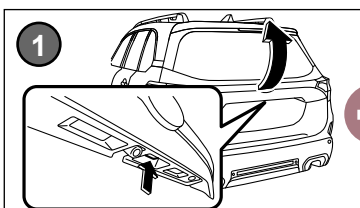

Im Falle einer Kollision mit Airbagauslösung und/oder Aktivierung der Gurtstraffer wird das Antriebssystem deaktiviert. Die Rückhaltesysteme sind noch aktiv.

ID Nr.	Versions-Nr.	Versions-Datum	Seite
JF1-T8380DE	03	11/2024	2 / 4

2B. <Alternative> Unterbrechung des 12V-Stromkreises



Falls die Masseklemme der 12V-Batterie nicht entfernt werden kann, kann der 12V-Stromkreis nicht abgeschaltet werden. Seien Sie beim Arbeiten vorsichtig, da sich das SRS-Airbag-System durch einen Kurzschluss oder einen Stoß auf den Kabelstrang plötzlich ausdehnen kann, was zu schweren Verletzungen führen kann.

<Die Masseklemme vom Batteriesensor trennen>

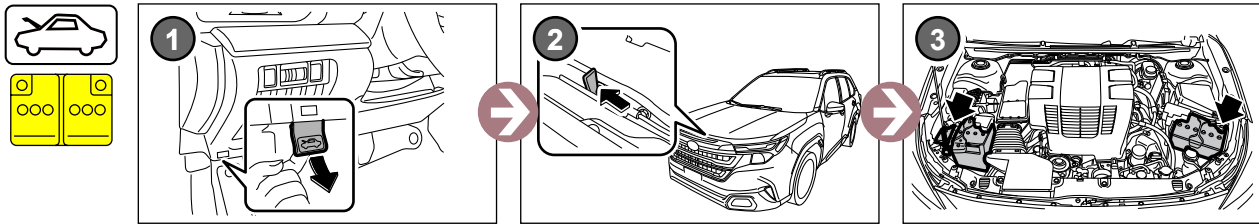

<Alternativ entfernen Sie die SICHERUNG>

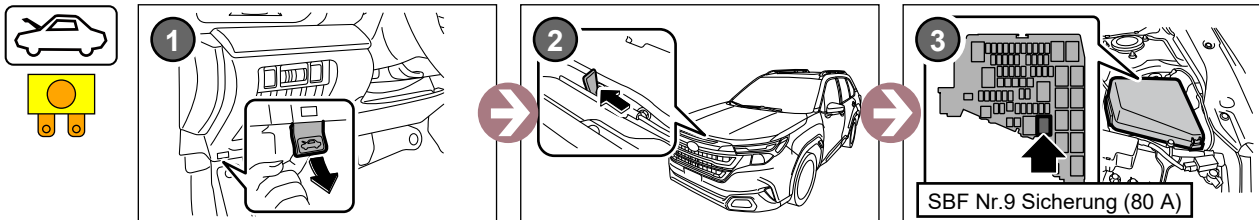

4. Zugang zu den Insassen

■ Fensterscheiben

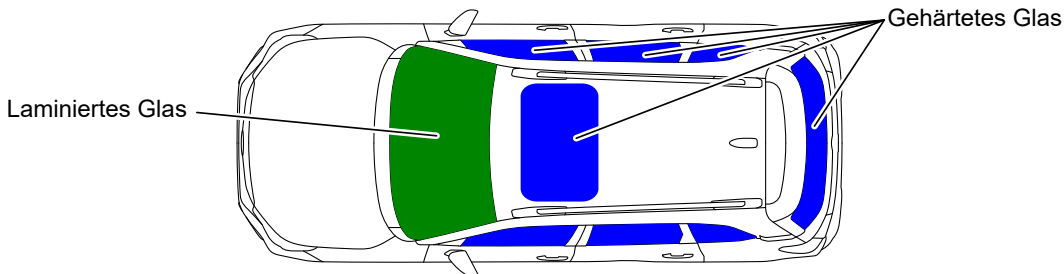

■ Sitzverstellung

<Elektrisch>

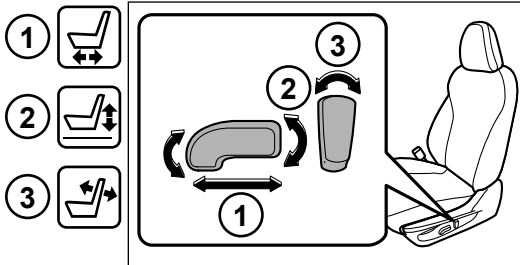

<Manuell>

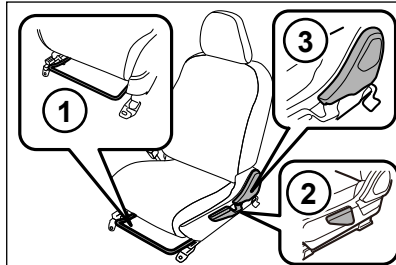

■ Einstellung der Lenksäule

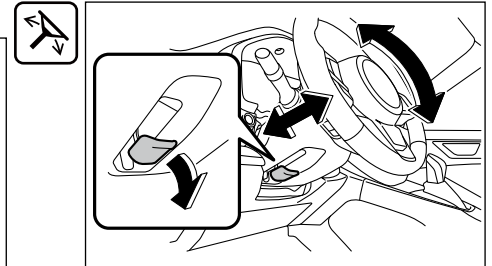

■ Hochfestigkeitsstahl in Karosserie

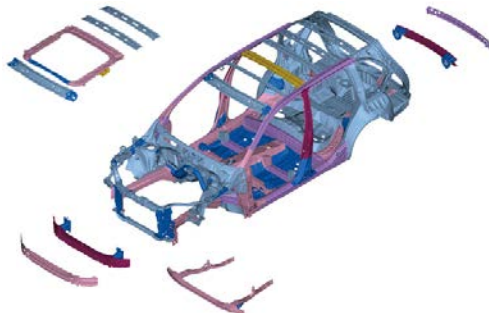

- 270 MPa (2.753 kgf /cm², 39.150 psi)
- 340 MPa (3.467 kgf /cm², 49.299 psi)
- 400 bis 440 MPa (4.079 bis 4.487 kgf /cm², 57.999 bis 63.799 psi)
- 590 MPa (6.016 kgf /cm², 85.549 psi)
- 980 MPa (9.993 kgf /cm², 140.299 psi)
- 1.180 MPa (12.032 kgf /cm², 171.098 psi)
- 1.500 MPa (15.295 kgf /cm², 217.498 psi)

■ Türschlösser

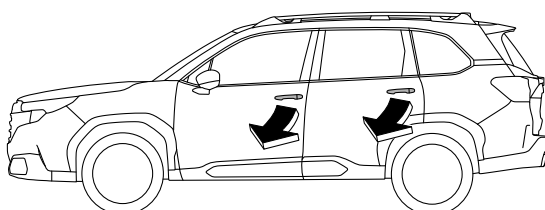



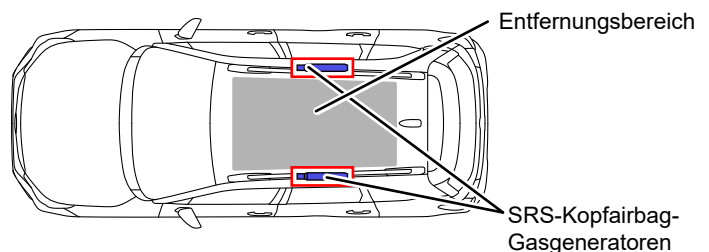





■ Dachentfernungsbereich





ID Nr.	Versions-Nr.	Versions-Datum	Seite
JF1-T8380DE	03	11/2024	3 / 4

5. Gespeicherte Energie/Flüssigkeiten/Gase/Feststoffe

	Lithium-Ionen: 118,4 V	
	12 V	
	48 L	
	HFO-1234yf - Linkslenker : 0,475 kg (1,05 lb) - Rechtslenker : 0,425 kg (0,94 lb)	



6. Im Brandfall

	REICHLICH WASSER VERWENDEN	Wenn es schwierig ist, reichlich Wasser auf die Hochspannungsbatterie anzuwenden, empfiehlt es sich, die Hochspannungsbatterie sich selbst ausbrennen zu lassen.
	WIEDERENTZÜNDUNG MÖGLICH!	

7. Im Falle des Untertauchens

	Berühren Sie nicht den Service-Trennstecker, die Hochspannungsteile und die Verkabelung, um einen Stromschlag zu vermeiden, wenn das Fahrzeug eingetaucht ist. Bitte schalten Sie das Hybridsystem ab, nachdem Sie das Fahrzeug vollständig aus dem Wasser gezogen haben.
---	--

8. Abschleppen/Transport/Lagerung

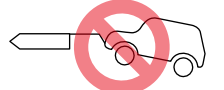
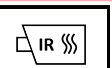





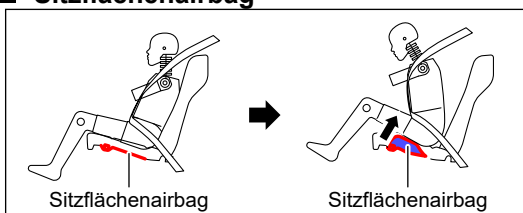

	Weniger als 30 km/h (19 MPH)	
	WIEDERENTZÜNDUNG MÖGLICH!	Stellen Sie das Fahrzeug mit ausreichend Sicherheitsabstand zu anderen Fahrzeugen ab.
Position des vorderen Hakens 	Position des hinteren Hakens 	Position der Werkzeuge 

9. Wichtige zusätzliche Informationen

■ Sitzflächenairbag



10. Erläuterung der verwendeten Piktogramme

	Elektrohybridfahrzeug mit flüssigen Kraftstoffen der Kl. 2		Klimaanlage		Motorhaube
	Regelung der Lenkradneigung		Sitzhöhenverstellung		Sitzlehnenverstellung
	Horizontale Sitzverstellung		Gefahr		Spannungsgefahr
	Smart-Schlüssel entfernen		IR-Wärmebildkamera benutzen		Entzündbar
	Gas unter Druck		Explosiv		Akute Toxizität
	Korrosiv		Gesundheitsschädlich		Anschlagpunkt